



# Diaflex

25 år - siden 1994

SE BAGSIDEN

**NYHED**  
**DPV3500 Hybrid Børemotor fra Cardi.biz Italien**  
Diaflex A/S er officiel forhandler af Cardi.biz siden 2014. Cardi.biz har et stort sortiment af professionelle værktøjer til byggebranchen. Alle Cardi.biz værktøjer er af høj kvalitet og leveres med garanti. Hvis du har brug for hjælp til valg af værktøj, kan du kontakte vores tekniske support på telefon eller e-mail.  
**DPH3000 med Støvsug** er en professionel støvsuger til byggebranchen. Den er ideel til at fjerne støv og snavs fra arbejdsområdet. Den har en stor kapacitet og er nem at betjene. Hvis du har brug for hjælp til valg af støvsuger, kan du kontakte vores tekniske support på telefon eller e-mail.

**DBH3000 Verdensnyhed fra Cardi.biz Italien**  
Diaflex A/S er officiel forhandler af Cardi.biz siden 2014. Cardi.biz har et stort sortiment af professionelle værktøjer til byggebranchen. Alle Cardi.biz værktøjer er af høj kvalitet og leveres med garanti. Hvis du har brug for hjælp til valg af værktøj, kan du kontakte vores tekniske support på telefon eller e-mail.  
**DPH3000 med Støvsug** er en professionel støvsuger til byggebranchen. Den er ideel til at fjerne støv og snavs fra arbejdsområdet. Den har en stor kapacitet og er nem at betjene. Hvis du har brug for hjælp til valg af støvsuger, kan du kontakte vores tekniske support på telefon eller e-mail.

**SERVICECENTER FOR CARDI OG WEKA**  
**VI AFHENTER OG LEVERER**

Diaflex er importer og salg af professionelle værktøjer til byggebranchen. Vi har et stort sortiment af værktøjer til byggebranchen. Hvis du har brug for hjælp til valg af værktøj, kan du kontakte vores tekniske support på telefon eller e-mail.  
Ring til 75 77 34 00 eller på [info@diaflex.dk](mailto:info@diaflex.dk)  
© Diaflex A/S 2019

IKAST  
75 77 34 00

ROSKILDE  
40 55 60 33

INCISOR ER NU TILBAGE



\* Spørg efter den.

DIAMANTBOR – RENOVERING AF BOR  
KERNEBOR MASKINER – STANDERE  
GULVSKÆREMASKINER – VÆGSAVE  
GULVSLIBNING – DIAMANTKLINGER  
INDUSTRISTØVSUGERE

**Diaflex A/S**

Lene Haus Vej 17B, 7430 Ikast

75773400

[www.diaflex.dk](http://www.diaflex.dk) - [diaflex@diaflex.dk](mailto:diaflex@diaflex.dk)

**Diaflex A/S Filial**

Håndværkervej 16, 4000 Roskilde

56663400

[www.diaflex.dk](http://www.diaflex.dk)





Filial: Håndværkervej 16, Roskilde  
40 55 60 33

## DIAFLEX KATALOG 2019

Dette katalog er beregnet for vores kunder indenfor dansk håndværk og industri. På de følgende sider præsenteres en stor del af vores program - primært indenfor diamantværktøj og maskiner, samt tape og krympeflex.

Diaflex har siden 1994 været aktør på dette marked, og har fra starten forenet service, kvalitet og en fair pris for at kunne give kunderne den fulde pakke.

Stor gensidigt loyalitet har vi kvitteret for med stor tak. Mere end 25 år i branchen er derfor også jeres garanti for at vi i de næste mange år fortsat er et sikker valg, når kvalitet og service har betydning. Diaflex har fra starten været baseret på produkter fra europæiske producenter. Brands som Carbodiam (Belgien); Samich, Maker og Cardi alle fra Italien, og senest Sept Tools fra Frankrig. Alle er på hvert deres felt markedsledende og blandt de mest innovative i markedet.

Europæisk leverandører foretrækkes. Den korte afstand fra nabolandene sikre hurtig forsyning, når det må kræves. De opfylder naturligvis de ufravigelige EU normer, og er vores kunders garanti og forsikring, hvis uheldet måtte være ude.

Diaflex har firmadomicil midt i Jylland, nærmere bestemt Ikast, hvor vi siden 2014 har haft til huse med mere 600m2 lagerhal og butik. På Sjælland har vi filial i Roskilde.

På landevejen har vi 6 landsdækkende sælgere, der sammen med personale på lager og kontor, opretholder virksomhedens serviceprofil.

Ring endelig for besøg:

Boas Laursen	Jesper Kaster	Jørn Nørgaard	Ole Ejstrud	Lasse Olsen	Mogens Eskildsen
20 83 60 36	20 32 60 32	52 23 91 91	52 23 77 74	22 22 41 71	40 68 00 74

VELKOMMEN,  
Mogens Eskildsen  
40 68 00 74

Roskilde Afdeling  
40 55 60 33



BESØG VORES BUTIK PÅ LENE HAUS VEJ 17B ▪ 7430 IKAST  
WWW.DIASHOP.DK





## 1 - Diamantbor

Vådbor, tørbor, adaptere, forlængere, slaganker, tilbehør i øvrigt

Side 7 - 30



## 2 - Renovering af bor

Segmenter, råbor

Side 31 - 39



## 3 - Boremaskiner

Diamantboremaskiner, standere, tilbehør  
El - kædesav CARDI

Side 40 - 50



## 4 - SEPT-Tools

Side 50 - 54



## 5 - Diamantklinger

Håndholdte maskiner og skærebørde

Side 55 - 65



## 6 - Diamantklinger

Gulvsavsmaskiner

Side 66 - 75



## 7 - Diamantklinger

Vægsavsmaskiner

Side 76 - 77



## 8 - Diamantslibning

Skiver, slibemaskiner

Side 78 - 95

# Diaflex

**Diaflex A/S**

Lene Haus Vej 17B, 7430 Ikast

75773400

www.diaflex.dk - diaflex@diaflex.dk

**Diaflex A/S** Filial

Håndværkervej 16, 4000 Roskilde

56663400

## 9 - Tape & Krympeflex

Tape, krympeflex, tinmuffer

Side 96 - 103



- Armeret beton
- Hurtig start—høj output
- Let at centrere - selvcentrende profil
- Segmenthøjde: 10mm
- Nyttelængde Ø15 - 32: 350mm - Gevind: 1/2"
- Nyttelængde Ø34 - 41: 450mm - Gevind: 1/2"



**DIAFLEX  
ANBEFALER**

Ø	Varenr.	Segment- bredde	Kode	Pris Dkr
8	206293	2,0	DFK08	kr. 854,76
10	206295	2,0	DFK10	kr. 907,80
12	206297	2,0	DFK12	kr. 919,02
14	206299	2,0	DFK14	kr. 923,10
15	206300	2,5	DFK15	kr. 953,70
16	206301	2,5	DFK16	kr. 957,78
18	206302	2,5	DFK18	kr. 985,32
20	206303	2,5	DFK20	kr. 993,48
22	206304	2,5	DFK22	kr. 1.002,66
24	206305	2,5	DFK24	kr. 102,00
25	206306	2,5	DFK25	kr. 1.058,76
26	206307	2,5	DFK26	kr. 1.061,82
28	206308	2,5	DFK28	kr. 1.080,18
30	206309	2,5	DFK30	kr. 1.105,68
32	206310	2,5	DFK32	kr. 1.174,02
35	206311	3,0	DFK35	kr. 1.208,70
36	206312	3,0	DFK36	kr. 1.230,12
38	206313	3,0	DFK38	kr. 1.323,96
40	206314	3,0	DFK40	kr. 1.354,56
41	206315	3,0	DFK41	kr. 1.366,80
42	206316	3,5	DFK42	kr. 1.419,84
52	206317	3,5	DFK52	kr. 1.704,42



## FCJC - TORNADOR Continuous Rings

- Armeret beton
- Nyttelængde: 350mm - Gevind: 1/2"
- Højt output
- Segmenthøjde: 10mm
- Kvik start-up
- Effektiv afkøling 2 x 2 vandveje



Ø	Varenr.	Segment-bredde	Kode	Pris Dkr
10	206201	2,0	FCJC0001	kr. 860,88
12	206202	2,0	FCJC0002	kr. 869,04
13	206203	2,0	FCJC0003	kr. 881,28
14	206204	2,0	FCJC0004	kr. 922,08
15	206115	2,5	FCJC0005	kr. 922,08
16	206116	2,5	FCJC0006	kr. 922,08
18	206118	2,5	FCJC0007	kr. 971,04
20	206120	2,5	FCJC0008	kr. 975,12
22	206122	2,5	FCJC0009	kr. 979,20
24	206124	2,5	FCJC0011	kr. 999,60
25	206125	2,5	FCJC0012	kr. 1.032,24
26	206126	2,5	FCJC0013	kr. 1.036,32
28	206128	2,5	FCJC0014	kr. 1.052,64
30	206130	2,5	FCJC0015	kr. 1.077,12
32	206132	2,5	FCJC0016	kr. 1.138,32
35	206135	2,5	FCJC0018	kr. 1.166,88
36	206136	2,5	FCJC0019	kr. 1.195,44
38	206138	2,5	FCJC0020	kr. 1.289,28
40	206140	2,5	FCJC0021	kr. 1.326,00
41	206141	2,5	FCJC0022	kr. 1.326,00

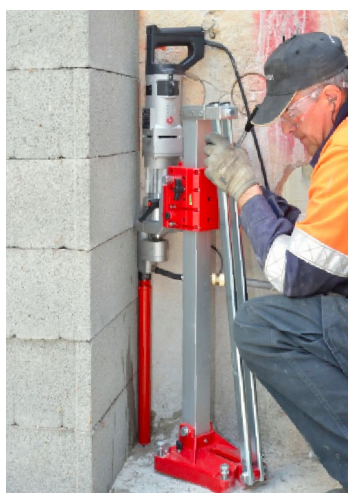
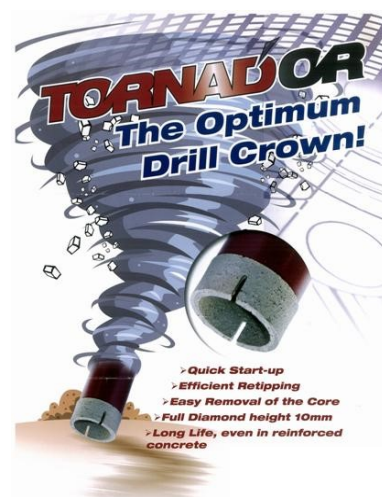



## FJM - Tyndvægget

- Byggematerialer
- Nyttelængde: 450mm - Gevind: 5/4" \*
- Segmenthøjde: 10mm
- Højt output



Ø	Varenr.	Segment-bredde	Kode	Pris Dkr
51	157303	2,5	FJMC0048	kr. 1.603,44
56	157304	2,5	FJMC0049	kr. 1.627,92
61	157305	2,5	FJMC0050	kr. 1.685,04
66	157306	2,5	FJMC0051	kr. 1.750,32
71	157307	2,5	FJMC0052	kr. 1.754,40
76	157308	2,5	FJMC0053	kr. 1.889,04
81	157309	2,5	FJMC0054	kr. 1.950,24
86	157310	2,5	FJMC0055	kr. 1.995,12
91	157311	2,5	FJMC0056	kr. 2.076,72
101	157312	2,5	FJMC0057	kr. 2.423,52
111	157314	2,5	FJMC0058	kr. 2.860,08
116	157315	2,5	FJMC0059	kr. 2.958,00
121	157316	2,5	FJMC0060	kr. 2.798,88
126	157317	2,5	FJMC0061	kr. 2.917,20
131	157318	2,5	FJMC0062	kr. 3.219,12
141	157319	2,5	FJMC0063	kr. 3.529,20
151	157320	2,5	FJMC0064	kr. 3.635,28
161	157321	2,5	FJMC0065	kr. 3.924,96
171	157322	2,5	FJMC0066	kr. 5.132,64
181	157323	2,5	FJMC0067	kr. 5.736,48
191	157324	2,5	FJMC0068	kr. 7.694,88
200	157325	2,5	FJMC0069	kr. 8.249,76

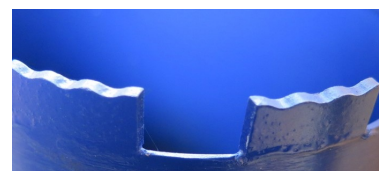
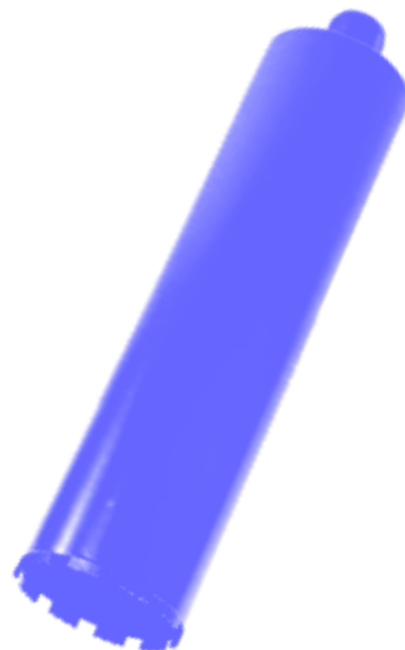

## Double point PIXI



- Hurtig boring
- Armeret beton
- Gammel beton

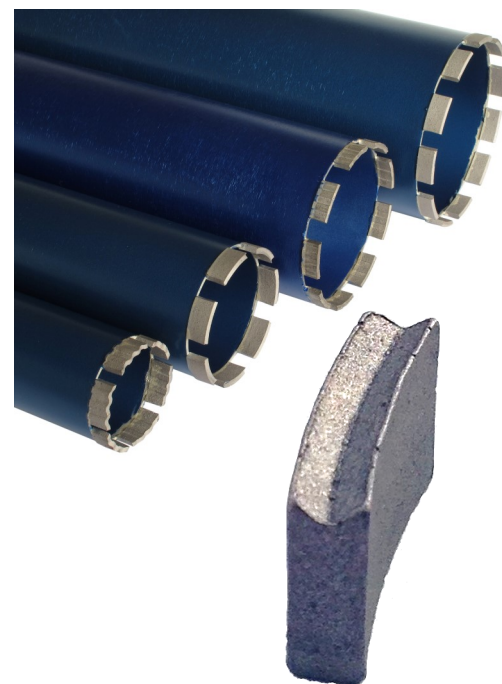

Vandopsamlingsring  
- se tilbehør side 20

Ø	Varenr.	Segment- bredde	Kode	Pris Dkr
51	157848	PIXI 3,5	FVLC0001PX	kr. 1.432,08
56	157849	PIXI 3,5	FVLC0002PX	kr. 1.432,08
61	157850	PIXI 3,5	FVLC0003PX	kr. 1.591,20
66	157851	PIXI 3,5	FVLC0004PX	kr. 1.599,36
71	157852	PIXI 3,5	FVLC0005PX	kr. 1.599,36
76	157853	PIXI 3,5	FVLC0006PX	kr. 1.778,88
81	157854	PIXI 3,5	FVLC0007PX	kr. 1.778,88
86	157855	PIXI 3,5	FVLC0008PX	kr. 1.986,96
91	157856	PIXI 3,5	FVLC0009PX	kr. 2.207,28
101	157857	PIXI 3,5	FVLC0011PX	kr. 2.276,64
106	157858	PIXI 3,5	FVLC0012PX	kr. 2.309,28
111	157859	PIXI 4,0	FVLC0014PX	kr. 2.578,56
121	157860	PIXI 4,0	FVLC0016PX	kr. 2.631,60
126	157861	PIXI 3,5	FVLC0017PX	kr. 2.700,96
131	157862	PIXI 4,0	FVLC0020PX	kr. 2.864,16
141	157865	PIXI 4,0	FVLC0022PX	kr. 3.394,56
151	157867	PIXI 4,0	FVLC0023PX	kr. 3.423,12
161	157872	PIXI 4,0	FVLC0025PX	kr. 3.708,72
171	157875	PIXI 4,0	FVLC0027PX	kr. 3.847,44
181	157876	PIXI 4,0	FVLC0029PX	kr. 3.912,72
200	157878	PIXI 4,0	FVLC0033PX	kr. 4.284,00
219	157880	PIXI 4,0	FVLC0035PX	kr. 5.124,48
225	157882	PIXI 4,0	FVLC0053PX	kr. 5.124,48
250	157884	PIXI 4,6	FVLC0037PX	kr. 5.858,88
299	157886	PIXI 4,6	FVLC0039PX	kr. 7.303,20
350	157888	PIXI 4,6	FVLC0041PX	kr. 8.180,40
399	157890	PIXI 4,6	FVLC0043PX	kr. 9.942,96
451	157892	PIXI 4,6	FVLC0045PX	kr. 11.497,44
499	157895	PIXI 5,0	FVLC0048PX	kr. 13.219,20
550	157896	PIXI 5,0	FVLC0049PX	kr. 14.051,52
599	157898	PIXI 5,0	FVLC0051PX	kr. 15.124,56

## Double point 5/4"



- Hurtig boring
- Armeret beton
- Gammel beton

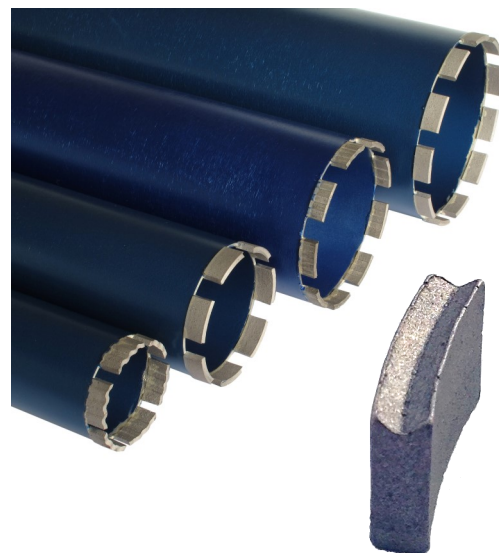

**CARDI 183 - Motor T2000 Me-14 + L180 stander**  
2000W - Kapacitet Ø32 til Ø202  
Integreret udsugningssystem.

Se side 40 - 49

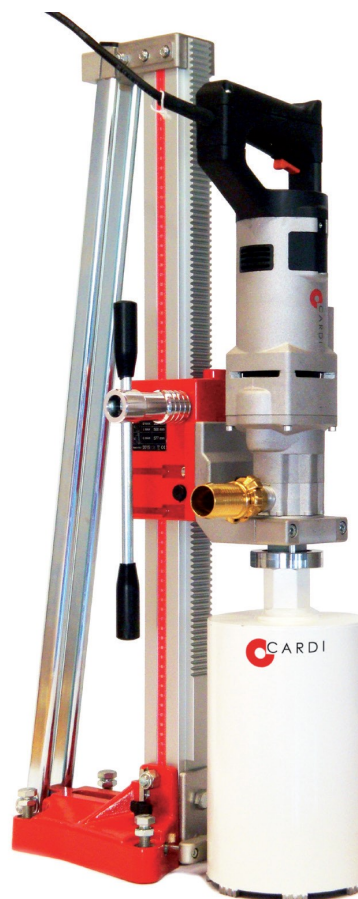

Ø	Varenr.	Segment- bredde	Kode	Pris Dkr	
51	157900	5/4"	3,5	FVLC0001	kr. 1.432,08
56	157901	5/4"	3,5	FVLC0002	kr. 1.432,08
61	157902	5/4"	3,5	FVLC0003	kr. 1.591,20
66	157903	5/4"	3,5	FVLC0004	kr. 1.599,36
71	157904	5/4"	3,5	FVLC0005	kr. 1.599,36
76	157905	5/4"	3,5	FVLC0006	kr. 1.778,88
81	157906	5/4"	3,5	FVLC0007	kr. 1.778,88
86	157908	5/4"	3,5	FVLC0008	kr. 1.986,96
91	157909	5/4"	3,5	FVLC0009	kr. 2.207,28
101	157911	5/4"	3,5	FVLC0011	kr. 2.276,64
106	157912	5/4"	3,5	FVLC0012	kr. 2.309,28
111	157913	5/4"	4,0	FVLC0014	kr. 2.578,56
121	157914	5/4"	4,0	FVLC0016	kr. 2.631,60
126	157915	5/4"	3,5	FVLC0017	kr. 2.700,96
131	157918	5/4"	4,0	FVLC0020	kr. 2.864,16
141	157921	5/4"	4,0	FVLC0022	kr. 3.394,56
151	159723	5/4"	4,0	FVLC0023	kr. 3.423,12
161	157925	5/4"	4,0	FVLC0025	kr. 3.708,72
171	157927	5/4"	4,0	FVLC0027	kr. 3.847,44
181	157928	5/4"	4,0	FVLC0029	kr. 3.912,72
200	157935	5/4"	4,0	FVLC0033	kr. 4.284,00
219	157937	5/4"	4,0	FVLC0035	kr. 5.124,48
225	157939	5/4"	4,0	FVLC0053	kr. 5.124,48
250	157941	5/4"	4,6	FVLC0037	kr. 5.858,88
299	157943	5/4"	4,6	FVLC0039	kr. 7.303,20
350	157945	5/4"	4,6	FVLC0041	kr. 8.180,40
399	157947	5/4"	4,6	FVLC0043	kr. 9.942,96
451	157949	5/4"	4,6	FVLC0045	kr. 11.497,44
499	157952	5/4"	5,0	FVLC0048	kr. 13.219,20
550	157953	5/4"	5,0	FVLC0049	kr. 14.051,52
599	157955	5/4"	5,0	FVLC0051	kr. 15.124,56



Ø	PIXI	5/4"	Anbefalet antal platter	Pris Dkr
76	F12074	F11074	5	kr. 1.773,78
138	F12136	F11136	10	kr. 3.258,90
186	F12184	F11184	12	kr. 4.583,88
226	F12224	F11224	16	kr. 5.799,72
276	F12274	F11274	18	kr. 7.424,58
341	F12339	F11339	21	kr. 8.581,26

## [RONDA STØVSUGER]

- Effekt: 2550 W
- Vægt: 46 / 48 kg
- Mål: Højde 132 cm
- Leveres komplet med slange og div. mundstykker

## RONDA 2000



Vare	Varenr.	Pris Dkr
RONDA 2000 - Støvsuger 2550 W, Højde 132 cm	407010	kr. 18.130,50

**FJPC SHARKOR - Hard Concrete**

- TurboStart (Selvskærpene segmenter)
- Bølgede sider = mindre friktion, højere hastighed
- Armeret beton og flint
- Højt output
- Nyttelængde på bor: 450mm - Gevind: 5/4"
- Segmenter er 12mm høje > 50% længere levetid
- Segmentlængde: 24mm

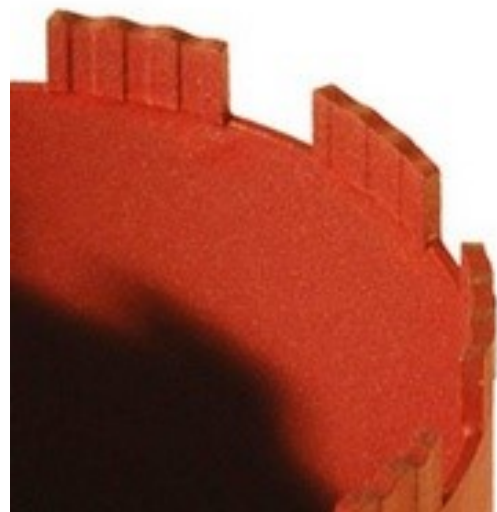

Ø	Varenr.	Segment- bredde	Kode	Pris Dkr
51	206615	3,5	FJPC2002	kr. 1.542,24
56	206616	3,5	FJPC2004	kr. 1.542,24
61	206617	3,5	FJPC2006	kr. 1.721,76
66	206618	3,5	FJPC2008	kr. 1.734,00
71	206619	3,5	FJPC2010	kr. 1.734,00
76	206620	3,5	FJPC2012	kr. 1.933,92
81	206621	3,5	FJPC2014	kr. 1.933,92
86	206622	3,5	FJPC2016	kr. 2.137,92
91	206623	3,5	FJPC2018	kr. 2.411,28
96	206624	3,5	FJPC2020	kr. 2.607,12
101	206625	3,5	FJPC2022	kr. 2.476,56
106	206626	3,5	FJPC2025	kr. 2.513,28
111	206627	4,0	FJPC2028	kr. 2.721,36
121	206628	4,0	FJPC2031	kr. 2.774,40
126	206629	4,0	FJPC2034	kr. 2.843,76
131	206630	4,0	FJPC2036	kr. 3.019,20
141	206631	4,0	FJPC2039	kr. 3.578,16
151	206632	4,0	FJPC2043	kr. 3.729,12
161	206633	4,0	FJPC2046	kr. 4.039,20
171	206634	4,0	FJPC2049	kr. 4.173,84
181	206635	4,0	FJPC2052	kr. 4.320,72
200	203636	4,0	FJPC2054	kr. 4.859,28
219	206637	4,0	FJPC2056	kr. 5.438,64
250	206638	4,6	FJPC2058	kr. 6.246,48
299	206639	4,6	FJPC2060	kr. 7.768,32
351	206641	4,6	FJPC2062	kr. 8.694,48
399	206642	5,0	FJPC2064	kr. 10.571,28
451	206643	5,0	FJPC2066	kr. 12.133,92
499	206644	5,0	FJPC2068	kr. 13.576,20

## Roof Top - Hard Concrete



- Long Life
- Armeret beton
- Gammel beton
- Segmenthøjde: 11,5mm
- Segmentlængde: 24mm



Ø	Varenr. 5/4"	Varenr. Pixi	Segment-bredde	Pris Dkr
51	100101	100201	3,5	kr. 1.436,16
56	100102	100202	3,5	kr. 1.436,16
61	100103	100203	3,5	kr. 1.590,18
66	100104	100204	3,5	kr. 1.602,42
71	100105	100205	3,5	kr. 1.602,42
76	100106	100206	3,5	kr. 1.782,96
81	100107	100207	3,5	kr. 1.782,96
86	100108	100208	3,5	kr. 1.987,98
91	100109	100209	3,5	kr. 2.215,44
96	100110	100210	3,5	kr. 2.262,36
101	100111	100211	3,5	kr. 2.283,78
106	100112	100212	3,5	kr. 2.318,46
111	100113	100214	4,0	kr. 2.587,74
121	100114	100216	4,0	kr. 2.639,76
126	100118	100217	4,0	kr. 2.680,56
131	100115	100218	4,0	kr. 2.870,28
141	100122	100220	4,0	kr. 2.994,72
151	100123	100221	4,0	kr. 3.020,22
161	100125	100222	4,0	kr. 3.273,18
171	100127	100224	4,0	kr. 3.855,60
181	100129	100226	4,0	kr. 3.919,86
200	100133	100230	4,0	kr. 3.101,82
220	100135	100235	4,0	kr. 5.128,56
250	100137	100238	4,6	kr. 5.860,92
299	100140	100240	4,6	kr. 7.451,10
351	100141	100241	4,6	kr. 8.346,66
399	100144	100244	5,0	kr. 10.304,04
451	100146	100246	5,0	kr. 11.895,24
499	100148	100248	5,0	kr. 13.489,50

### CARDI 189



Se side xx

**DRILL 5C** 

- Segmenthøjde: 9,5mm
- Hurtig boring
- Nyttelængde 450 mm - Gevind 5/4"
- Armeret beton, gl. beton



Ø	Varenr.	Segment- bredde	Pris Dkr
51	157502	3,5	kr. 1.413,72
56	157504	3,5	kr. 1.418,82
61	157506	3,5	kr. 1.568,76
66	157508	3,5	kr. 1.581,00
71	157510	3,5	kr. 1.581,00
76	157512	3,5	kr. 1.773,78
81	157514	3,5	kr. 1.773,78
86	157516	3,5	kr. 1.979,82
91	157518	3,5	kr. 2.202,18
101	157522	3,5	kr. 2.270,52
106	157526	3,5	kr. 2.305,20
111	157529	3,5	kr. 2.570,40
121	157532	4,0	kr. 2.621,40
126	157535	4,0	kr. 2.690,76
131	157537	4,0	kr. 2.853,96
141	157540	4,0	kr. 3.380,28
151	157542	4,0	kr. 3.410,88
161	157545	4,0	kr. 3.693,42
171	157548	4,0	kr. 3.834,18
181	157551	4,0	kr. 3.898,44
200	157553	4,0	kr. 4.271,76
219	157556	4,0	kr. 5.111,22
250	157558	4,0	kr. 5.852,76
299	157560	4,6	kr. 7.300,14
351	157565	4,6	kr. 8.306,88
399	157567	4,6	kr. 10.102,08
451	157569	5,0	kr. 11.661,66
499	157571	5,0	kr. 13.015,20

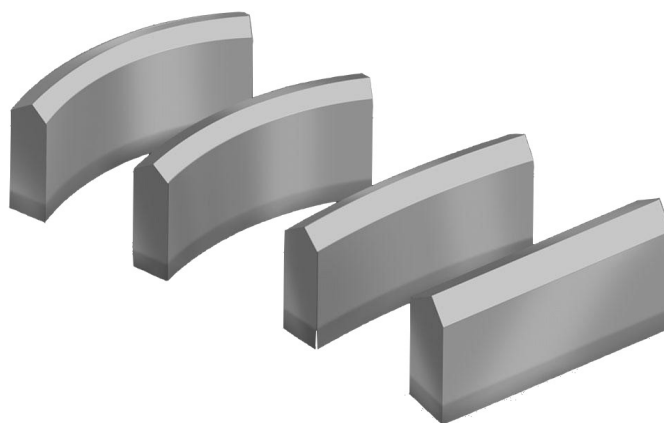

[FAC Wavor - Asfalt]



- TurboStart (Selvskærpene segmenter)
- Asfalt
- Nyttelængde: Ø>48: 450mm - Gevind: 5/4"
- Segmenthøjde: 10mm
- Segmentlængde: 24mm



Ø	Varenr.	Antal Segmenter	Segment-bredde	Kode	Pris Dkr
81	157626	7	3,5	FAC1007	kr. 1.936,98
86	157627	7	3,5	FAC1008	kr. 2.142,00
91	157628	9	3,5	FAC1009	kr. 2.408,22
101	157630	9	3,5	FAC1011	kr. 2.476,56
106	157631	9	3,5	FAC1012	kr. 2.511,24
111	157633	10	4,0	FAC1014	kr. 2.819,28
121	157635	10	4,0	FAC1016	kr. 2.870,28
126	157637	10	4,0	FAC1018	kr. 2.939,64
131	157639	11	4,0	FAC1020	kr. 3.127,32
141	157641	13	4,0	FAC1022	kr. 3.705,66
151	157643	13	4,0	FAC1024	kr. 3.744,42
161	157646	14	4,0	FAC1027	kr. 4.057,56
171	157649	14	4,0	FAC1030	kr. 4.194,24
181	157652	14	4,0	FAC1033	kr. 4.258,50
200	157656	15	4,0	FAC1037	kr. 4.657,32
219	157658	15	4,0	FAC1039	kr. 5.496,78
250	157660	18	4,6	FAC1041	kr. 6.336,24
299	157662	22	4,6	FAC1043	kr. 7.887,66
326	157664	22	4,6	FAC1045	kr. 8.525,16
351	157666	23	4,6	FAC1047	kr. 8.787,30
399	157668	28	4,6	FAC1049	kr. 10.659,00
451	157670	30	4,6	FAC1051	kr. 12.257,34
499	157673	33	5,0	FAC1054	kr. 13.940,34





## FJMC - Tyndvægget

- Byggematerialer
- Nyttelængde: 300mm - Gevind: 5/4" \*
- Segmenthøjde: 10mm
- Højt output



Ø	Varenr.	Segment-bredde	Kode	Pris Dkr
56	157406	2,5	FJMC0002	kr. 1.727,88
61	157407	2,5	FJMC0003	kr. 1.731,96
66	157408	2,5	FJMC0028	kr. 1.736,04
71	157409	2,5	FJMC0029	kr. 1.740,12
76	157410	2,5	FJMC0006	kr. 1.978,80
81	257411	2,5	FJMC0030	kr. 2.041,02
86	157412	2,5	FJMC0031	kr. 2.086,92
91	157413	2,5	FJMC0032	kr. 2.455,14
101	157414	2,5	FJMC0010	kr. 2.647,92
106	157415	2,5	FJMC0033	kr. 3.279,30
111	157418	2,5	FJMC0034	kr. 3.366,00
121	157419	2,5	FJMC0036	kr. 3.066,12
126	157420	2,5	FJMC0061	kr. 3.183,42
131	157421	2,5	FJMC0062	kr. 3.677,10
141	157422	2,5	FJMC0063	kr. 3.772,98
151	157423	2,5	FJMC0064	kr. 3.805,62
161	157424	2,5	FJMC0065	kr. 4.663,44
171	157425	2,5	FJMC0066	kr. 5.495,76
181	157426	2,5	FJMC0067	kr. 6.328,08
191	157427	2,5	FJMC0068	kr. 8.469,06
200	157428	2,5	FJMC0069	kr. 8.966,82

\* også i 1/2" gevind



**[TØRBOR MED SUG]**

- Tørboring med sug - Ingen støvgéner
- Minimalt oprydning efter boring
- Mursten, let beton
- Nyttelængde: 150mm



Ø	Varenr.	Antal segmenter	Pris Dkr
68	15750	3	kr. 1.183,20
82	15753	4	kr. 1.280,10
92	15755	4	kr. 1.308,66
102	15757	4	kr. 1.338,24
107	15758	4	kr. 1.357,62
112	15759	4	kr. 1.357,62
122	15761	4	kr. 1.396,38
127	15762	4	kr. 1.450,44
132	15763	4	kr. 1.462,68
142	15765	5	kr. 1.554,48
152	15767	5	kr. 1.613,64
162	15769	5	kr. 1.773,78
186	15774	6	kr. 2.009,40

**[RONDA STØVSUGER]**

- Effekt: 1100 W
- Vægt: 15 kg
- Mål: Højde 80 cm
- Leveres komplet med slange og div. mundstykker

Vare	Varenr.	Pris Dkr
RONDA 200H - Støvsuger tør 1200W, Højde 80 cm	407000	6395

**RONDA 200H**

**[TØRBOR]**

- Mursten, let beton
- Nyttelængde: 160mm











Ø	Varenr.	Antal segmenter	Pris Dkr
32	15402	3	kr. 890,46
37	15403	3	kr. 904,74
42	15404	3	kr. 927,18
47	15405	3	kr. 937,38
52	15406	3	kr. 947,58
57	15407	3	kr. 957,78
62	15408	3	kr. 1.033,26
68	15409	3	kr. 1.158,72
72	15410	4	kr. 1.173,00
77	15411	4	kr. 1.229,10
82	15412	4	kr. 1.293,36
87	15413	4	kr. 1.356,60
92	15414	4	kr. 1.387,20
102	15416	4	kr. 1.486,14
107	15417	4	kr. 1.562,64
112	15418	4	kr. 1.685,04
122	15420	4	kr. 1.813,56
132	15422	4	kr. 2.005,32
138	15423	4	kr. 2.484,72
142	15424	5	kr. 1.420,86
152	15426	5	kr. 1.520,82
162	15428	5	kr. 1.620,78
167	15430	5	kr. 1.649,34

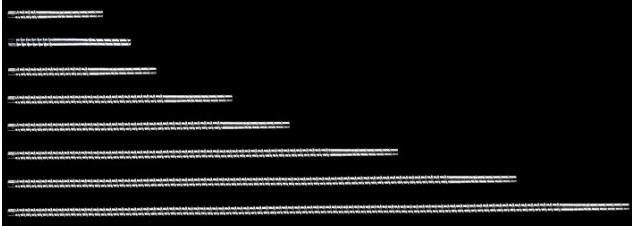

**[ADAPTERE] [STØV-OPSAMLERE] [SUGEHOVED] [VANOPSAMLINGS-RINGE]**

			
Indv. 5/4" - udv. Pixi Varenr. 15010 kr. 1124,04	Indv. 5/4" - indv. 1/2" Varenr. 15015 kr. 468,18	Indv. 5/4" - udv. M30 Varenr. 15020 kr. 612,00	Indv. Pixi - udv. 5/4" Varenr. 15025 kr. 574,26
			
Indv. Pixi - indv. 1/2" Varenr. 15024 kr. 457,98	Udv. Pixi - udv. 1/2" Varenr. 15030 kr. 1134,24	Udv. 5/4" - Udv. 1/2" Varenr. 15032 kr. 493,66	Udv. 1/2" - Udv. M16 Varenr. 15035 kr. 612,00
			
Udv. 5/4" gevind- M16 indv. gevind for pit til boremaskine - kan bruges både med vand og sug. Varenr. 15080 kr. 948,60	Indv. 1/2" - Udv. 6-kantet fæste m/ vandstuds Varenr. 09990 kr. 1202,58	STØV OPSAMLER - 1"1/4 UNC (f) - 1"1/4 UNC (m) - 1/2 G (f) Varenr. 390726 kr. 2013,48	STØV OPSAMLER - PIXI (f) - PIXI (m) Varenr. 390752 kr. 2013,48
VANDOPSAMLINGSRINGE (WSR) 	Forsegling skive f. WSR m/ skala 	Gummi-forsegling f. WSR 	
380010 - Ø100mm kr. 1.193 380011 - Ø150mm kr. 1.271 380012 - Ø200mm kr. 1683 380013 - Ø250mm kr. 1.789 380014 - Ø300mm kr. 2.189 380015 - Ø350mm kr. 2.801	380040 f. Ø100 kr. 149 380041 f. Ø150 kr. 165 380042 f. Ø200 kr. 188 380043 f. Ø250 kr. 222 380044 f. Ø350 kr. 298	380020 - pr./mtr. kr. 214 380021 sæt f. Ø100 Kr. 129 380022 sæt f. Ø150 Kr. 141 380023 sæt f. Ø200 Kr. 175 380024 sæt f. Ø250 Kr. 208 380025 sæt f. Ø350 Kr. 226	

**[Bolte] [Anker]**

			
Bolt m/fjeder (L) 15340 kr. 836	Bolt u/ fjeder (L) 15341 kr. 410	Bolt M12 m/flytbar disc 15342 kr. 47	K50 Fjeder bolt size M 15343 kr. 836
Anker skruer		Fastgørelse bolte / Snapgevind	
			
15305 K50 / 65	Kr. 363	15320 M16 / B 15/250	Kr. 222
15306 K50 / 65 HW	Kr. 412	15321 M16 / B 15/300	Kr. 233
15307 K50 / 165	Kr. 388	15322 M16 / B 15/400	Kr. 257
15308 K50 / E250	Kr. 422	15323 M16 / B 15/500	Kr. 282
15309 K50 / 300	Kr. 381	15324 M16 / B 15/800	Kr. 424
15310 K50 / 400	Kr. 463	15325 M16 / B 15/1000	Kr. 557
15311 K50 / 600	Kr. 512	15326 M12 / B 15/250	Kr. 222
15312 K50 / 800	Kr. 664	15327 M12 / B 15/300	Kr. 233
15313 K50 / 1000	Kr. 816	15328 M12 / B 15/500	Kr. 282
15314 K50 / 130 M12	Kr. 351	15329 M12 / B 15/800	Kr. 424
15315 K50 / 155 M12	Kr. 363	15330 M12 / B 15/1000	Kr. 557
15316 K50 / 170 M12	Kr. 373		
			
Bolt u/fjeder (M) 15344 kr. 520	Bolt u/fjeder (S) 15345 kr. 361	Bolt m/fjeder (S) 15346 kr. 738	Kontra møtrik f. MFP B15 15347 kr. 200

**[Bolte]**

				
MFP-Multimonterings plate 15348 kr. 6242	MFP-Multimonterings plate m/ vacuum 15349 kr. 9421	Låse skrue for MFP SW13 15390 B15/150 kr. 151 15391 B15/200 kr. 180	15392 B15/250 15393 B15/300 15394 B15/350	kr. 192 kr. 206 kr. 224
				
AHV - Løfte hængsel/2 tons 15331 AHL2 kr. 1410	AHV - Løfte hængsel/2 tons 15332 AHR2 kr. 2297	AHV - Løfte hængsel/500kg. 15333 AHVSG kr. 1.246	Reserve bolt f. AHV 15334 AHVM kr. 410	
				
K50-Lift manuel Størrelse 122x33cm, Swingpipe 61cm. Max bæreevne 408kg. Inkl. Wheelpipe og swingpipe		408020 kr. 30.961	K50 - Sharpening plate for diamant kernebor og diamant klinger 320x320x55	15335 kr. 1357

**[PROTECTOR]**

			<b>Tilbehør Protector 1.0</b> Net f. Protector 1.0                    408011                    Kr. 596 Hose f. Protector 1.0                    408012                    Kr. 1826 10 mtr. w/ connections Hose f. waste water 10 mtr.        408013                    Kr. 3025 1", inkl. 2xGeka-coupling Hose f. waste water 5 mtr.        408014                    Kr. 1722 1", inkl. 2xGeka-coupling		
Protector 1.0	408010	kr. 21.624			
			Nut f. telescope ratchet 1/2" 13mm 		
Telescope ratchet 1/2"	408015	kr. 333	Kort	408016	kr. 129
			Lang	408017	Kr. 253
					
Multi pillar 1,55 - 2,90 mtr. 150-450 kg	408025	kr. 1073	Core catcher 300x300	15336	kr. 3905
Multi pillar 2,0 - 3,75 mtr. 70-450 kg.	408026	kr. 1151	Core catcher 500x500	15337	kr. 4090
Tripod for Multi pillar -450 kg.	408027	kr. 1214	Core catcher 300x1000	15338	kr. 4129
			Core catcher 500x1000	15339	kr. 4449

[SLAGANKRE]

[SNAPGEVIND]

[HAMMERBOR]

[SLAGDORNE]

		 <p>x 200</p> <p>+</p>
<p>Slaganker M12 udv. 16mm (50 stk.) - Beton Varenr. 15374                      Kr. 3,06/stk.</p>		<p>Slagankersæt til beton Varenr. 101100                      kr. 1095</p>
	<p>Slagankersæt m/250 stk. M12 + Dorn Varenr. 15365                      kr. 933</p>	<p>Slagankersæt til beton Varenr. 101100                      kr. 1095</p>
		
<p>Snapgevind M12 220/25mm Varenr. 15351                      kr. 448</p>	<p>Snapgevind M12 250/80mm Varenr. 15352                      kr. 448</p>	
		
	<p>Hammerbor SDS+ Ø16mm 160/100 Varenr. 15387                      kr. 100</p>	<p>Dorn for slaganker Varenr. 15381 M12                      kr. 214 Varenr. 15382 M16                      kr. 214</p>



**[FASTNØGLER]****[KOBBERINGE]****[SPÆNDSØJLE]****[BÆREHÅNDTAG]**

		
<b>FASTNØGLER</b> Vnr. 965010 SW22                      kr.. 111 Vnr. 965011 SW24                      kr. . 123 Vnr. 965012 SW32                      kr. . 199 Vnr. 965002 SW41                      kr. . 355 Vnr. 965013 SW46                      kr. . 439	<b>KOBBERINGE</b> For let afmontering af bor Salgsenhed : 50 stk./pose  Varenr. 965001                      kr. 43 / stk.	<b>CARDIFACILE</b> Hurtig afmonterings enhed for kernebor Universel til brug for standard 5/4"  Varenr. 390707                      kr. 708
		
<b>BOR UDTRÆKKER</b> - Let udtræk af fastkilede bor  Varenr. 199999                      kr. 1831	<b>BÆREHÅNDTAG</b>  Varenr. 108510 5/4"                      kr. 641 Varenr. 108515 Pixi                      kr. 641	<b>SPÆNDSØJLE</b> 170 - 300cm Belastning 500 kg Mulighed for fin justering  Varenr. 965000                      kr. 3167
		
	<b>Trykspand 10 L. 3 bar</b> Varenr. 390755                      kr. 1200	<b>Trykspand 10 L. 6 bar</b> Varenr. 390756                      kr. 1967

**[FORLÆNGERE] [RENOVERING]**

																																
<p>Forlængere 1/2" - sort stål</p> <table border="0"> <tr><td>13100 100mm</td><td>kr. 364</td></tr> <tr><td>13200 200mm</td><td>kr. 353</td></tr> <tr><td>13300 300mm</td><td>kr. 818</td></tr> <tr><td>13400 400mm</td><td>kr. 921</td></tr> <tr><td>13500 500mm</td><td>kr. 1061</td></tr> </table>	13100 100mm	kr. 364	13200 200mm	kr. 353	13300 300mm	kr. 818	13400 400mm	kr. 921	13500 500mm	kr. 1061	<p>Forlængere 5/4" -sort stål</p> <table border="0"> <tr><td>14100 100mm</td><td>kr. 500</td></tr> <tr><td>14200 200mm</td><td>kr. 734</td></tr> <tr><td>14300 300mm</td><td>kr. 1000</td></tr> <tr><td>14400 400mm</td><td>kr. 1171</td></tr> <tr><td>14500 500mm</td><td>kr. 1260</td></tr> </table>	14100 100mm	kr. 500	14200 200mm	kr. 734	14300 300mm	kr. 1000	14400 400mm	kr. 1171	14500 500mm	kr. 1260	<p>Forlængere PIXI -sort stål</p> <table border="0"> <tr><td>14610 100mm</td><td>kr. 1077</td></tr> <tr><td>14620 200mm</td><td>kr. 1332</td></tr> <tr><td>14630 300mm</td><td>kr. 1795</td></tr> <tr><td>14640 400mm</td><td>kr. 2060</td></tr> <tr><td>14650 500mm</td><td>kr. 2232</td></tr> </table>	14610 100mm	kr. 1077	14620 200mm	kr. 1332	14630 300mm	kr. 1795	14640 400mm	kr. 2060	14650 500mm	kr. 2232
13100 100mm	kr. 364																															
13200 200mm	kr. 353																															
13300 300mm	kr. 818																															
13400 400mm	kr. 921																															
13500 500mm	kr. 1061																															
14100 100mm	kr. 500																															
14200 200mm	kr. 734																															
14300 300mm	kr. 1000																															
14400 400mm	kr. 1171																															
14500 500mm	kr. 1260																															
14610 100mm	kr. 1077																															
14620 200mm	kr. 1332																															
14630 300mm	kr. 1795																															
14640 400mm	kr. 2060																															
14650 500mm	kr. 2232																															
 <p style="text-align: center;"><b>LETVÆGT</b></p>																																
<p>Forlængere 5/4" Aluminium</p> <table border="0"> <tr><td>14101 100mm</td><td>kr. 476</td></tr> <tr><td>14201 200mm</td><td>kr. 697</td></tr> <tr><td>14301 300mm</td><td>kr. 923</td></tr> <tr><td>14401 400mm</td><td>kr. 974</td></tr> <tr><td>14501 500mm</td><td>kr. 1052</td></tr> </table>	14101 100mm	kr. 476	14201 200mm	kr. 697	14301 300mm	kr. 923	14401 400mm	kr. 974	14501 500mm	kr. 1052	<p>Borkapmaskine (Depositum, udlån)</p> <p>100820 kr. 3570</p>	<p>Sølvstænger</p> <table border="0"> <tr><td>101014</td><td>dagspris</td></tr> <tr><td>101015 - høj temperatur</td><td>dagspris</td></tr> </table>	101014	dagspris	101015 - høj temperatur	dagspris																
14101 100mm	kr. 476																															
14201 200mm	kr. 697																															
14301 300mm	kr. 923																															
14401 400mm	kr. 974																															
14501 500mm	kr. 1052																															
101014	dagspris																															
101015 - høj temperatur	dagspris																															
																																
<p>Magneter</p> <table border="0"> <tr><td>101000 0,75 / 1,00</td><td>kr. 176</td></tr> <tr><td>101010 0,50 / 1,25</td><td>kr. 176</td></tr> </table>	101000 0,75 / 1,00	kr. 176	101010 0,50 / 1,25	kr. 176	<p>Fluss</p> <p>101011 0,5kg kr. 515</p>	<p>Sortimentsboks til segmenter</p> <p>101112 kr. 153</p>																										
101000 0,75 / 1,00	kr. 176																															
101010 0,50 / 1,25	kr. 176																															

**[FORLÆNGERE] [PIT] [CENTERBOR] [ADAPTERE]**

		
<b>Forlængere M16 - sort stål</b>  14810 100mm                      kr. 428 14820 200mm                      kr. 510 14830 300mm                      kr. 530 14850 500mm                      kr. 551	<b>Indv. 1/2" - Udv. 6-kantet fæste m/ vandstuds</b>  Varenr. 09990                      kr. 1203	<b>Usv. 1/2" - Udv. M16</b>  Varenr. 15035                      kr. 612
		
<b>Sugehoved til tørbor</b>  Varenr. 15700                      kr. 580	<b>Pit til tørbor M16</b> 15040 SDS+ 100mm                      kr. 301 15046 SDS+ 220mm                      kr. 384 15042 6-kantet 100mm                      kr. 107 15047 6-kantet 220mm                      kr. 214 15048 6 kantet 350mm                      kr. 237	<b>Centerbor</b>  15400 f. tørbor 160mm                      kr. 193 15708 f. tørbor m. sug                      kr. 193

**CARDIFACILE - KVIK KERNEBOR AFMONTERINGS ENHED 5/4"**

Varenr.	KOMPATIBILITET	kr.
506102	Håndholdt kernebor	657
505355	Alle Cardi kernebor	799

**KOBBER RING FOR 5/4" BOREHOVED**

HØJ TYKKELSE (4 mm) OG LANG LEVETID

Varenr.	KOMPATIBILITET	kr.
501818	Alle Cardi kernebor med 5/4"	43

**CENTER GUIDE ENHED FOR HÅNDHOLDT BORING**

For 5/4" kernebor

Varenr.	KERNEBOR GEVIND	kr.
504840	5/4" + 1/2"	424
504841	5/4" + HUL Ø19mm	424

**CENTRERINGS ENHED FOR HÅNDHOLDT BORING**

Med innovativ roterende ende- for borehoved 5/4" L=250mm

Varenr.	KERNEBOR GEVIND	kr.
506149	5/4" + 1/2"	909
506151	5/4" + HUL Ø19mm	909

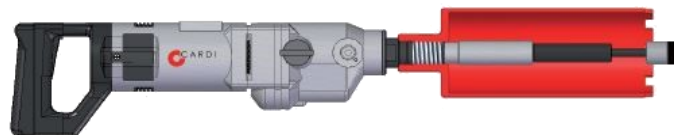
**MOTORMONTERINGS PLADER**

Varenr.	BESKRIVELSE	kr.
505035	Plade for montering af håndholdte kernebor: Borestander L 160—L 180	334
505036	Plade for montering af håndholdte kernebor: Borestander L 200 - L 250 - L 300	435
505040	4 huls motor monterings plade for borestander L 200	334
505039	6 huls motor monterings plade for borestander L 250 - L 300	374
504870	6 huls motor monterings plade for borestander C 520	746
505936	6 huls motor monterings plade for borestander C 600 - C600-1500	1212
505937	Motor monterings plade for borestander CARDI 805 - CARDI 1005	1616



**AFSTANDSSKIVER**

Varenr.	BESKRIVELSE	kr.
502545	H = 20 mm - 4 huller	344
502296	H = 50 mm - 4 huller	486
506148	H = 30 mm (L 160 - L 180)	606
506132	H = 30 mm + collar 60 mm L 200 - L 250 - L 300	939
501899	H = 20 mm - 6 huller	486
501852	H = 45 mm - 6 huller	737
501654	H = 60 mm - 6 huller	737
506107	H = 80 mm - 6 huller	929
501634	H = 110 mm - 6 huller	1120
506106	H = 37 mm CARDI 805 / 1005	929
506105	H = 105 mm CARDI 805 / 1005	3837

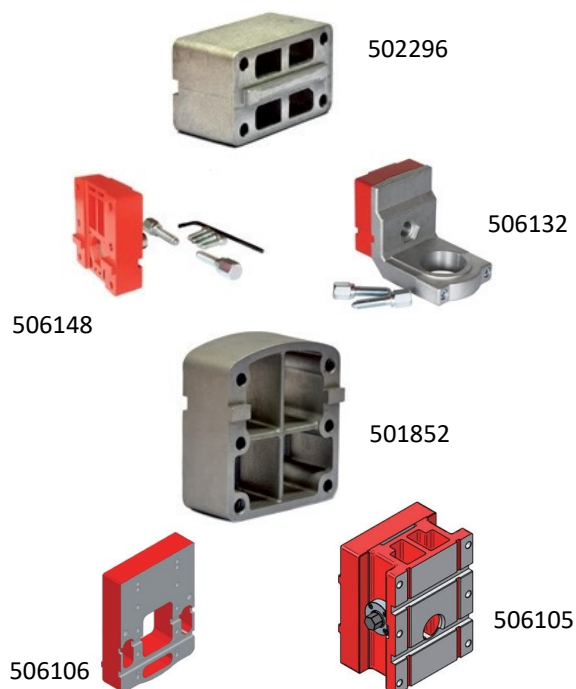
**STØVSUGER**

Varenr.	BESKRIVELSE	kr.
ASP 1	Støvsuger 1200W - ekstra 230V stik til elværktøj	7993



ASP 1

**VAKUUM-FASTGØRELSE**

For boring maks diameter 250 mm

Varenr.	BESKRIVELSE	kr.
505066	Vakuumbase Kit 250x250 mm (styrke ~300 kg)	1656
505063	Vakuumbase Kit 300x330 mm (styrke ~500 kg)	2071
PV 4-S	Vakuumpumpe Med sikkerhedstank	6838



505066



PV 4-S

**ANKERMONTERING**

Varenr.	BESKRIVELSE	kr.
503628	Snapgevind	449
15374	50 slaganker M12 u/krave	dagspris
15381	Dorn for slaganker M12	214



503628



15381



15374

**VANDOPSAMLINGSSÆT FOR KERNEBOR**

Maks Diameter 150 og 250 mm

Varenr.	BORE STANDSMODELLER	Ø mm	kr.
505062	L160 - L180 - L200 - L250 - L300	250	1697
503999	C520 - C600 - C600-1500	250	1768
501712	(ekstra gummi skive)	250	202
505061	L160 - L180 - L200 - L250 - L300	150	1343
501111	(ekstra gummi skive)	150	101

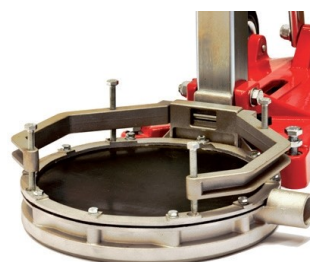

505061



501111

**VÆGKLEMME MONTAGE ENHED**

Varenr.	BESKRIVELSE	kr.
503183	Montering af borestander i f.eks. vinduesåbning	2202

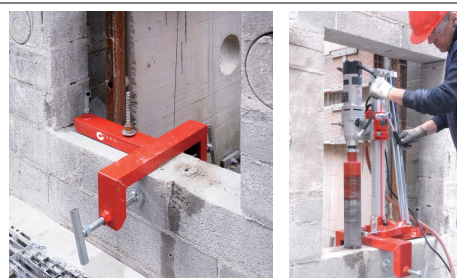

503183

**CORNER JACK**

Til boring glat med væg (eller gulv) og ind i hjørnerne

Varenr.	BESKRIVELSE	kr.
502305	Kompatibel med alle CARDI håndholdte kerneboremaskiner og med boremotor T1 200-EL	3332

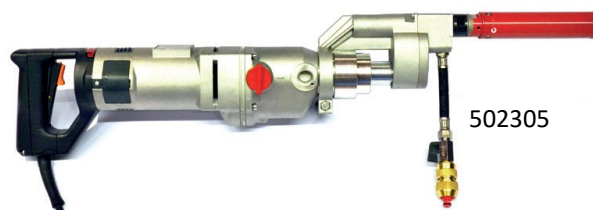

502305

**SKINNE FASTGØRELSESTILBEHØR**

Varenr.	BORE STANDSMODELLER	kr.
505064	L160 - L180 - L200 - L250 - L300	1111
503160	C520 - C600 - C600-1500	1111

**RESERVEDELE / TILBEHØR**

Varenr.	BESKRIVELSE	kr.
504568	Vand slange sæt til kernebore motor	354
500101	Vand-stop vand slange forbindelse	142
506050	Vand indløb og ventil til ME kernebore motorer	162
504207	Støvsuger forbindelse	82
502143	Håndtag til håndholdte Kernebore motor	193
503940	Kul sæt for CARDI kernebore motor	214
503392	PRCD 10mA 220V 16A	930

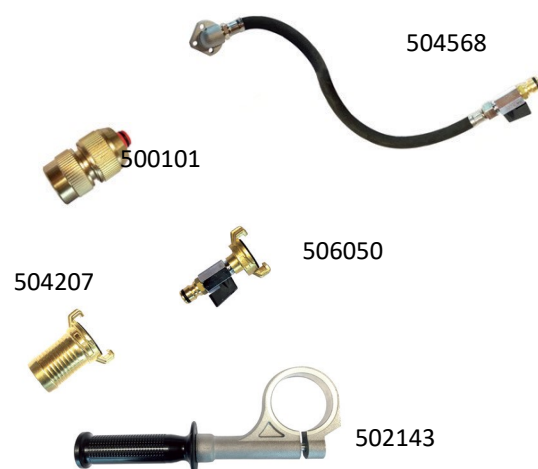

504568

500101

506050

504207

502143

## [FCJ - Tornador]



- Armeret beton, granit
- Høj output
- Let at centrere - selvcentrende profil
- Segmenthøjde: 10 mm
- Motor =<2000W
- Effektiv afkøling 2 x 2 vand veje



Ø	Varenr.	Segment- bredde	Kode	Pris Dkr
10	100073	2,0	FCJS0001	kr. 274,38
12	100074	2,0	FCJS0002	kr. 278,46
13	100075	2,0	FCJS0003	kr. 291,72
14	100076	2,0	FCJS0004	kr. 291,72
15	100077	2,5	FCJS0005	kr. 330,48
16	100078	2,5	FCJS0006	kr. 334,56
18	100079	2,5	FCJS0007	kr. 381,48
20	100080	2,5	FCJS0008	kr. 385,56
22	100082	2,5	FCJS0009	kr. 390,66
24	100083	2,5	FCJS0011	kr. 406,98
25	100084	2,5	FCJS0012	kr. 420,24
26	100085	2,5	FCJS0013	kr. 424,32
28	100086	2,5	FCJS0014	kr. 437,58
30	100087	2,5	FCJS0015	kr. 463,08
32	100088	2,5	FCJS0016	kr. 471,24
35	100090	2,5	FCJS0018	kr. 488,58
36	100091	2,5	FCJS0019	kr. 501,84
38	100092	2,5	FCJS0020	kr. 514,08
40	100093	2,5	FCJS0021	kr. 535,50
41	100094	2,5	FCJS0022	kr. 548,76

**[DFS30 - Continuous Rings]** 

- Armeret beton, granit
- Høj output
- Let at centrere - selvcentrende profil
- Segmenthøjde: 10 mm
- Motor =<2000W
- Effektiv afkøling 2 x 2 vand veje



Ø	Varenr.	Segment- bredde	Kode	Pris Dkr
8	206396	2,0		kr. 267,24
10	206397	2,0		kr. 279,48
12	206398	2,0		kr. 284,58
14	206399	2,0		kr. 296,82
15	206400	2,5		kr. 336,60
16	206401	2,5		kr. 340,68
18	206402	2,5		kr. 389,64
20	206403	2,5		kr. 393,72
22	206404	2,5		kr. 397,80
24	206405	2,5		kr. 416,16
25	206406	2,5		kr. 428,40
26	206407	2,5		kr. 433,50
28	206408	2,5		kr. 445,74
30	206409	2,5		kr. 472,26
32	206410	2,5		kr. 485,52
35	206411	3,0		kr. 505,92
38	206413	3,0		kr. 525,30
40	206414	3,0		kr. 550,80
42	206416	3,5		kr. 787,44
52	206426	3,5		kr. 970,02



## [Double Point]



- TurboStart (Selvskærpende segmenter)
- Armeret beton og flint
- Højt output
- Segmenthøjde: 10mm + 2
- Salgsenhed: 50 stk./pose



Ø	Varenr.	Segment-bredde (mm)	Segment højde (mm)	Segment-længde (mm)	Kode	Pris Dkr
48-55	105531	3,5	10+2	24	FVLD001	kr. 94,86
56-62	105532	3,3	10+2	24	FVLD002	kr. 94,86
63-72	105533	3,3	10+2	24	FVLD003	kr. 94,86
73-86	105534	3,5	10+2	24	FVLD004	kr. 94,86
87-108	105535	3,5	10+2	24	FVLD005	kr. 94,86
109-147	105537	3,5	10+2	24	FVLD007	kr. 94,86
109-147	105538	4,0	10+2	24	FVLD008	kr. 94,86
148-235	105539	4,0	10+2	24	FVLD009	kr. 94,86
148-235	105540	4,6	10+2	24	FVLD010	kr. 103,02
> 235	105542	5,0	10+2	24	FVLD012	kr. 107,10
> 235	105543	5,6	10+2	24	FVLD013	kr. 116,28
> 235	105546	6,1	10+2	24	FVLD014	kr. 116,28

## [FRTD - Roof Top Long Life]



- Lang levetid
- Armeret beton
- Gammel beton



Ø	Varenr.	Segment-bredde (mm)	Segment højde (mm)	Segment-længde (mm)	Pris Dkr
56-62	105504	3,5	12	24	kr. 90,78
63-72	105506	3,5	12	24	kr. 90,78
73-86	105508	3,5	12	24	kr. 90,78
87-108	105510	3,5	12	24	kr. 90,78
109-147	105511	3,5	12	24	kr. 94,86
109-147	105512	4,0	12	24	kr. 94,86
148-235	105514	4,0	12	24	kr. 94,86
148-235	105515	4,6	12	24	kr. 103,02
> 236	105517	5,0	12	24	kr. 107,10
> 236	105518	5,6	12	24	kr. 120,36

## [FAD Wavor - Asfalt]



- TurboStart (Selvskærpnde segmenter)
- Asfalt, basaltic beton, aluminatcement
- Segmenthøjde: 10mm
- Segmentlængde: 24mm
- Salgsenhed: 50 stk./pose

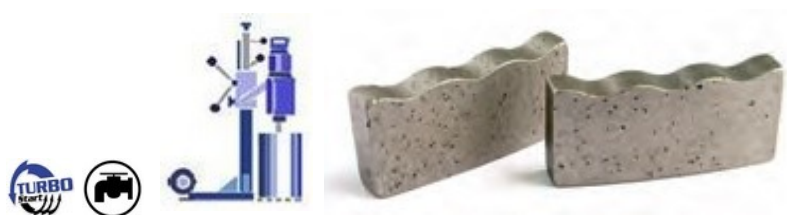

Ø	Varenr.	Segment- bredde (mm)	Segment højde (mm)	Segment- længde (mm)	Kode	Pris Dkr
50-55	106802	3,5	10	24	FAD1002	kr. 107,10
56-62	106804	3,5	10	24	FAD1004	kr. 107,10
63-72	106806	3,5	10	24	FAD1006	kr. 107,10
73-86	106808	3,5	10	24	FAD1008	kr. 107,10
87-108	106810	3,5	10	24	FAD1010	kr. 107,10
109-147	106811	3,5	10	24	FAD1011	kr. 107,10
109-147	106812	4,0	10	24	FAD1012	kr. 116,28
148-235	106813	3,5	10	24	FAD1013	kr. 107,10
148-235	106814	4,0	10	24	FAD1014	kr. 116,28
148-235	106815	4,6	10	24	FAD1015	kr. 124,44
> 235	106816	4,6	10	24	FAD1016	kr. 124,44
> 235	106817	5,0	10	24	FAD1017	kr. 133,62
> 235	106818	5,6	10	24	FAD1018	kr. 141,78

## [1/2" RÅBOR]

- Nyttelængde: 400mm



∅	Varenr.	Væg-tykkelse	Pris Dkr
17	10017	1,5	kr. 218,28
19	10019	1,5	kr. 229,50
21	10021	1,5	kr. 235,62
23	10023	1,5	kr. 241,74
25	10025	1,5	kr. 255,00
27	10027	1,5	kr. 257,04
28	10028	1,5	kr. 262,14
29	10029	1,5	kr. 269,28
30	10030	1,5	kr. 276,42
31	10031	1,5	kr. 276,42
32	10032	1,5	kr. 280,50
34	10034	1,5	kr. 292,74
35	10035	1,5	kr. 304,98
38	10038	1,5	kr. 320,28
39	10039	1,5	kr. 325,38
40	10040	1,5	kr. 329,46
41	10041	1,5	kr. 336,60
45	10045	1,5	kr. 352,92
50	10050	1,5	kr. 376,38
55	10055	1,5	kr. 398,82
60	10060	1,5	kr. 427,38
65	10065	1,5	kr. 561,00
70	10070	1,5	kr. 483,48
75	10075	1,5	kr. 503,88
80	10080	1,5	kr. 534,48
85	10085	1,5	kr. 697,68
90	10090	1,5	kr. 839,46
100	10100	1,5	kr. 847,62
110	10110	2,0	kr. 1.125,06

**[5/4" RÅBOR]**

- Nyttelængde: 400mm



Ø	Varenr.	Væg-tykkelse	Pris Dkr
40	11040	1,5	kr. 471,24
45	11045	1,5	kr. 489,60
50	11050	1,5	kr. 530,40
55	11055	1,5	kr. 601,80
60	11060	1,5	kr. 733,38
65	11065	1,5	kr. 742,56
70	11070	1,5	kr. 763,98
75	11075	1,5	kr. 785,40
80	11080	1,5	kr. 795,60
85	11085	1,5	kr. 825,18
90	11090	1,5	kr. 839,46
100	11100	1,5	#VÆRDI!
105	11105	2,0	kr. 912,90
110	11110	2,0	kr. 1.125,06
120	11120	2,0	kr. 1.209,72
125	11125	2,0	kr. 1.244,40
130	11130	2,0	kr. 1.294,38
136	11136	2,0	kr. 1.874,76
140	11140	2,0	kr. 1.460,64
150	11150	2,0	kr. 1.495,32
160	11160	2,0	kr. 1.565,70
165	11165	2,0	kr. 1.649,34
170	11170	2,0	kr. 1.687,08
180	11180	2,0	kr. 1.836,00
184	11184	2,0	kr. 1.767,66
198	11198	2,0	kr. 2.438,82
210	11210	2,0	kr. 2.566,32
220	11220	2,0	kr. 2.590,80
230	11230	2,0	kr. 2.902,92
248	11248	2,0	kr. 3.150,78

## [5/4" RÅBOR]

- Nyttelængde: 400mm / 450mm



Ø	Varenr.	Væg-tykkelse	Pris Dkr
260	11260	2,0	kr. 2.972,28
270	11270	2,0	kr. 3.484,32
280	11280	2,5	kr. 3.395,58
298	11298	2,5	kr. 3.956,58
323	11323	2,5	kr. 4.200,36
348	11348	2,5	kr. 4.592,04
380	11380	2,5	kr. 4.645,08
398	11398	2,5	kr. 4.746,06
420	11420	2,5	kr. 4.893,96
448	11448	2,5	kr. 5.047,98
498	11498	3,0	kr. 5.217,30
548	11548	3,0	kr. 6.429,06
598	11598	3,0	kr. 6.739,14
648	11648	3,0	kr. 7.052,28
698	11698	3,0	kr. 7.304,22

## [5/4" RÅBOR]

- Forsheda-mål:

Ø	Varenr.	Væg-tykkelse	Pris Dkr
136	11136	2,0	kr. 1.874,76
184	11184	2,0	kr. 1.767,66
224	11224	2,5	kr. 2.399,04
274	11274	2,5	kr. 3.298,68

**[PIXI RÅBOR]**

- Nyttelængde: 400mm / 450mm



Ø	Varenr.	Væg-tykkelse	Pris Dkr
50	12050	1,5	kr. 482,46
60	12060	1,5	kr. 666,06
65	12065	1,5	kr. 675,24
70	12070	1,5	kr. 694,62
75	12075	1,5	kr. 714,00
80	12080	1,5	kr. 722,16
85	12085	1,5	kr. 749,70
90	12090	1,5	kr. 760,92
100	12100	1,5	kr. 770,10
105	12105	2,0	kr. 829,26
110	12110	2,0	kr. 1.022,04
120	12120	2,0	kr. 1.099,56
125	12125	2,0	kr. 1.128,12
130	12130	2,0	kr. 1.176,06
140	12140	2,0	kr. 1.327,02
150	12150	2,0	kr. 1.359,66
160	12160	2,0	kr. 1.422,90
165	12165	2,0	kr. 1.499,40
170	12170	2,0	kr. 1.533,06
180	12180	2,0	kr. 1.668,72
198	12198	2,0	kr. 2.217,48
210	12210	2,0	kr. 2.332,74
220	12220	2,0	kr. 2.355,18
232	12232	2,0	kr. 2.638,74
248	12248	2,0	kr. 2.863,14

**[PIXI RÅBOR]**

- Nyttelængde: 400mm



Ø	Varenr.	Væg-tykkelse	Pris Dkr
260	12260	2,0	kr. 3.075,30
270	12270	2,0	kr. 3.167,10
280	12280	2,5	kr. 3.457,80
298	12298	2,5	kr. 3.596,52
323	12323	2,5	kr. 3.817,86
348	12348	2,5	kr. 4.173,84
380	12380	2,5	kr. 4.222,80
398	12398	2,5	kr. 4.314,60
420	12420	2,5	kr. 4.448,22
448	12448	2,5	kr. 4.588,98
498	12498	3,0	kr. 4.743,00
548	12548	3,0	kr. 5.843,58
598	12598	3,0	kr. 6.126,12
648	12648	3,0	kr. 6.419,88
698	12698	3,0	kr. 7.304,22

**[PIXI RÅBOR]**

- Forsheda-mål:

Ø	Varenr.	Væg-tykkelse	Pris Dkr
136	12136	2,0	kr. 1.184,22
184	12184	2,0	kr. 1.766,64
224	12224	2,5	kr. 2.399,04
274	12274	2,5	kr. 3.298,68

**[FLANGE]**

Gevind	Varenr.	Antal huller	Pris Dkr
5/4"	15300	6	kr. 1.108,74
Pixi	15301	6	kr. 1.108,74







## T2000 MS-13 HÅNDHOLDT KERNEBREMASKINE - TØR BORING

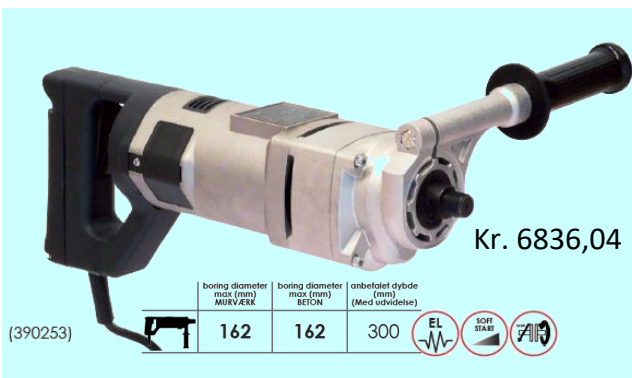

TEKNISKE SPECIFIKATIONER T2000 MS-13		
EFFEKT (230 V)	W	2000 (MAX 2200)
R.P.M. UBELASTET /BELASTET	R.p.m.	2000 / 1350
KAPACITET I MURVÆRK / ABRASIVE	Ø mm	32 - 162
KAPACITET I BETON	Ø mm	32 - 162
BORTILSLUTNING		M18 x 2,5
VÆGT	Kg	4,8
MEDFØLGENDE TILBEHØR		TRANSPORT KUFFERT

## T2000 MA-14 HÅNDHOLDT KERNEBREMASKINE - TØR BORING STØVSUGNINGSSYSTEM



TEKNISKE SPECIFIKATIONER T2000 MA-14		
EFFEKT (230 V)	W	2000 (MAX 2200)
R.P.M. UBELASTET /BELASTET	R.p.m.	1400 / 960
KAPACITET I MURVÆRK / ABRASIVE	Ø mm	32 - 202
KAPACITET I BETON	Ø mm	32 - 162
BORTILSLUTNING		5/4"
VÆGT	Kg	5,6
MEDFØLGENDE TILBEHØR		TRANSPORT KUFFERT

## T2000 ME-14 HÅNDHOLDT KERNEBREMASKINE TØR- & VÅDBORING MED STØVSUGNINGSSYSTEM

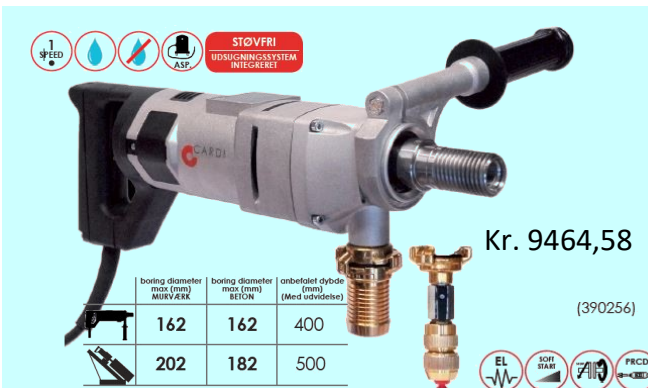

TEKNISKE SPECIFIKATIONER T2000 ME-14		
EFFEKT (230 V)	W	2000 (MAX 2200)
R.P.M. UBELASTET /BELASTET	R.p.m.	1400 / 960
KAPACITET I MURVÆRK / ABRASIVE	Ø mm	32 - 202
KAPACITET I BETON	Ø mm	32 - 162
BORTILSLUTNING		5/4"
VÆGT	Kg	5,6
MEDFØLGENDE TILBEHØR		TRANSPORT KUFFERT



## T1 ME-EL

HÅNDHOLDT KERNEBREMASKINE TØR- & VÅDBORING  
MED STØVSUGNINGSSYSTEM FOR INTENSIVT ARBEJDE





Kr. 12714,30

STØVFRI  
UDSUGNINGSSYSTEM  
INTEGRERET

3  
SPEED

WATER

ASP

	boring diameter max (mm) MURVÆRK	boring diameter max (mm) BETON	anbefalet dybde (mm) (Med udvidelse)
	182	182	400
	252	202	900

TEKNISKE SPECIFIKATIONER T1 ME-EL		
EFFEKT (230 V)	W	2200 (MAX 2650)
R.P.M. UBELASTET /BELASTET	G1	r.p.m. 750 / 530
	G2	r.p.m. 1800 / 1280
	G3	r.p.m. 2500 / 1780
KAPACITET I MURVÆRK / ABRASIVE	∅ mm	20 - 252
KAPACITET I BETON	∅ mm	20 - 202
BORTILSLUTNING		5/4"
VÆGT	Kg	7,3
MEDFØLGENDE TILBEHØR		TRANSPORT KUFFERT

## CARDI 183

HÅNDHOLDT KERNEBREMASKINE MED STANDER



## CARDI 189

HÅNDHOLDT KERNEBREMASKINE MED STANDER



TEKNISKE SPECIFIKATIONER T2000 ME-14 MED STANDER CARDI 183		
KERNEBREMOTOR MODEL		T2000 ME-14
BORE STANDER MODEL		L 180
SØJLE TILT		45°
VÆGT (MOTOR + STANDER)	Kg	5,6 + 10
MEDFØLGENDE TILBEHØR (MOTOR)		TRANSPORT KUFFERT
PRIS	kr.	14.722,68

TEKNISKE SPECIFIKATIONER T2000 ME-14 MED STANDER CARDI 189		
KERNEBREMOTOR MODEL		T1 ME-EL
BORE STANDER MODEL		L 180
SØJLE TILT		45°
VÆGT (MOTOR + STANDER)	Kg	7,3 + 10
MEDFØLGENDE TILBEHØR (MOTOR)		TRANSPORT KUFFERT
PRIS	kr.	18824,10

## CARDI 200

KERNEBOREMASKINE MED STANDER



## CARDI 400

KERNEBOREMASKINE MED STANDER



### TEKNISKE SPECIFIKATIONER

CARDI

KERNEBOREMOTOR MODEL			T1 200-EL	T6 375-EL
BORE STANDER MODEL			L 200	C520
EFFEKT (230 V)		W	2200 (MAX 2500)	3420 (MAX 4400)
R.P.M. UBELASTET /BELASTET	G1	r.p.m.	540 / 385	350 / 230
	G2	r.p.m.	1300 / 920	800 / 520
	G3	r.p.m.	1800 / 1280	1475 / 965
KAPACITET I BETON - VÅD		Ø mm	30 - 200	30 - 400
BORTILSLUTNING			5/4" + 1/2"	5/4"
VÆGT		Kg	19	41
PRIS		kr.	18.929,16	33.231,60

## CARDI 500

KERNEBOREMASKINE MED STANDER



## CARDI 501

KERNEBOREMASKINE MED STANDER



TEKNISKE SPECIFIKATIONER		CARDI 500	CARDI 501
KERNEBOREMOTOR MODEL		T9 475-EL	T4 300-EL
BORE STANDER MODEL		C 520	C 600
EFFEKT (230 V)	W	3420 (MAX 4400)	3420 (MAX 4400)
R.P.M. UBELASTET /BELASTET	G1 r.p.m.	300 / 190	300 / 190
	G2 r.p.m.	560 / 370	560 / 370
	G3 r.p.m.	920 / 600	920 / 600
	G4 r.p.m.	1540 / 1000	1540 / 1000
KAPACITET I BETON - VÅD	Ø mm	25 - 500	25 - 500
BORTILSLUTNING		5/4"	5/4"
VÆGT	Kg	42	46
PRIS	kr.	36.386,46	42.486,06

## CARDI 605 - 3 faser 380/400V

KERNEBREMASKINE MED STANDER / VANDKØLET MOTOR

## CARDI 805 - 3 faser 380/400V

KERNEBREMASKINE MED STANDER / VANDKØLET MOTOR



TEKNISKE SPECIFIKATIONER		CARDI 605	CARDI 805
KERNEBREMOTOR MODEL		FR 605	FR 805
BORE STANDER MODEL		C 520	C 600
EFFEKT (230 V)	W	4200 (MAX 5000)	6000 (MAX 7000)
R.P.M. UBELASTET /BELASTET	G1	r.p.m. 115	90
	G2	r.p.m. 185	195
	G3	r.p.m. 260	325
KAPACITET I BETON - VÅD	Ø mm	120 - 500	100 - 600
MAX KERNEBOR DIAMETER - U/AFSTANDSSTYKKE	Ø mm	452	566
MAX KERNEBOR DIAMETER - M/AFSTANDSSTYKKE inkl.	Ø mm	612 (506107)	640 (506106)
BORTILSLUTNING		5/4"	5/4"
VÆGT	Kg	50	67
PRIS	Dkr.	41.224,32	55.630,80

## C600 - 1500 EXTRA-LANG SØJLE

## SERVO 520 / DA VINCI SERVO SEMI-AUTOMATISK FEEDING SYSTEM



<b>CARDI C600-1500</b>	
PASSER TIL ALLE CARDI MOTORER	
PRIS	kr. 41.224,32

	SERVO 520	DA VINCI SERVO
PASSER TIL	C 520	C600, C600-1500, DA VINCI SYSTEM
SPECIFIKATIONER	BØRSTELØS MOTOR 24V-150W - KONTROL PANEL - FJERN KONTROL	
MAX BELASTNING	600 Kg	
PRIS	kr. 21.873,90	kr. 21.873,90

## CARDI PE 400

ELEKTRISK KLINGESAV - VÅDSKÆRING OGSÅ GLAT LANGS VÆG

## CARDI PE 401

ELEKTRISK KLINGESAV TØRSKÆRING MED DUST EXTRACTION  
GLAT VÅDSKÆRING TIL VÆG



TEKNISKE SPECIFIKATIONER		PE 400-BL	PE 401-BL
EFFEKT (230 V)	W	3420 (MAX 4400 / 6 hp)	3420 (MAX 4400 / 6 hp)
R.P.M. UBELASTET /BELASTET	r.p.m.	2870 / 1880	2870 / 1880
KLINGE DIAMETER	mm	400	400
KLINGE CENTER HUL	mm	25,4	25,4
MAXIMUM SKÆRE DYBDE	mm	160 (135 med støv udsugning)	160 (135 med støv udsugning)
FLANGE FOR GLAT SKÆRING		incl. som standard	Incl. som standard
STØV UDSUGNINGS TILBEHØR		tilbehør	Incl. som standard
VÆGT	Kg	13	14,5
PRIS	kr.	20.507,10	24.713,58

# CARDI PIRANHA 125-SX

MURRILLEFRÆSER - TØRSKÆRING MED STØVSUGNINGSSYSTEM



TEKNISKE SPECIFIKATIONER		PH 125-SX
EFFEKT (230 V)	W	2000 (MAX 2200)
R.P.M. UBELASTET /BELASTET	r.p.m.	7900 / 5000
KLINGE DIAMETER (antal og diameter)		2 x 125 mm
KLINGE CENTER HUL	mm	22,2
RILLE MAXIMUM BREDDE	mm	43
RILLE MAXIMUM DYBDE	mm	138,5
VÆGT	Kg	13
PRIS	kr.	20.507,10



## CARDI AL 18.43

ELEKTRONISK MOTORSÅV - TØRSKÆRING AF BLOKKE



## CARDI AL 22.53

ELEKTRONISK MOTORSÅV - TØRSKÆRING AF BLOKKE



TEKNISKE SPECIFIKATIONER		AL 18.43	AL 22.53
EFFEKT (230 V)	W	2000 (MAX 2200 / 2,95 hp)	2200 (MAX 2650 / 3,5 hp)
R.P.M. UBELASTET /BELASTET	r.p.m.	2850/ 1640	2800 / 1800
SVÆRD & HÅRD METAL KÆDE	cm	43	53
SAFETY BRAKE + TOTAL PROTECTION SYSTEM BY CARDI		JA	JA
KÆDE SMØRE METODE		KÆDESAV OLIE	KÆDESAV OLIE
VÆGT SVÆRD & KÆDE INKLUDERET	Kg	10	10,7
PRIS	kr.	13.145,76	15.249,00

## CARDI CD35.35

ELEKTRONISK DIAMANT MOTORSÅV - VÅDSKÆRING I BETON OG MARMOR



TEKNISKE SPECIFIKATIONER		CD35.35
EFFEKT (230 V)	W	3420 (MAX 4400 / 6 hp)
R.P.M. UBELASTET /BELASTET	r.p.m.	9400 / 6150
SKÆRE DYBDE	Mm	400
TOTAL PROTECTION SYSTEM BY CARDI		JA
KÆDE SMØRRELSE OG DIAMANT KØLING		VAND
VÆGT SVÆR OG KÆDE INKLUDERET	Kg	9
PRIS	kr.	23.976,12

## GIRAFO - Multihead og TURBO 7

GIRAFO & SEPT IU33 TURBO 7



GIRAFO

Orbital rotary head  
Ø225 mm

**Samlet pris:**  
Girafo + IU33 Turbo 7 + Orbital rotary head Ø225  
+ System kuffert

**Kr. 17383**

TEKNISKE SPECIFIKATIONER		IU33 TURBO 7 H11	GIRAFO	ORBITAL ROTARY HEAD
CODE		S931603	S950937	S950939
EFFEKT (230 V)	W	1600		
AIRFLOW		330m <sup>3</sup> / h		
KAPACITET		33L		
LYDNIVEAU		< 70 db		
FILTERSYSTEM		H11 / H12		
SYSTEM			Rotary / orbital rotary	
DIAMETER HOVED	mm		165 / 225	225
VÆGT	Kg	9,3	2,5	
PRIS	kr.		7.771,38	8.012,10
				1861,50

TILBEHØR		PRIS
S508640	System kuffert i kraftig plast	1.827,84
S598114	Anti statisk støvsuger slange	1.827,84
S598112	Adapter Ø40mm til IU33 W	175,44

## AIR JACKET - SCOURPIO

### AIR JACKET - SCOURPIO

- FORDELER BELASTNING
- JUSTERBAR BALANCE



Leveres med  
1 luftpumpe

TEKNISKE SPECIFIKATIONER		AIR JACKET - SCOURPIO	
Dimensioner	m	1,55 x 0,40 x 0,45	
MAX BELASTNING	Kg	10	
KABEL LÆNGDE	m	2,4	
VÆGT	Kg	6,9	
STØRRELSER - angiv		L - XL - XXL	
PRIS (\$495942)			10.835,46

## SLIDING BALANCER - GECKO

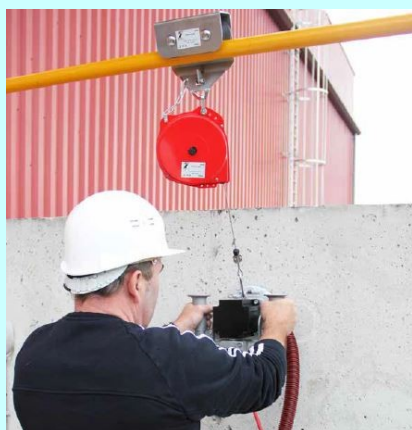

TEKNISKE SPECIFIKATIONER		SLIDING BALANCER - GECKO	
MAX BELASTNING	Kg	6 - 10	
KABEL LÆNGDE	m	2,4	
PRIS (\$495935)			7.497



## FOUINE—XB 135 / XB 165



TEKNISKE SPECIFIKATIONER		XB 135	XB 165
EFFEKT (230 V) output	W	1164	1552
HASTIGHED SPEED 1 / SPEED 2	rpm	3000 / 5500	2800 / 4800
VIBRATIONER	ms <sup>2</sup>	0.22	0.22
LYDNIVEAU	db	62	62
BESKYTTELSE		IP 64	IP 64
MAX HØJDE m/ GAZELLE	M	4,2	4,2
MAX HØJDE m/ GAZELLOTO	M	4,6	4,6
DIAMETER HOVED	mm	135	165
MONTERING AF VÆRKTØJ		Patented	Patented Daisy bore
VÆGT	Kg	6,9	7,6
PRIS m/ Elektronisk boks	kr.	(S966125) 32.560,44	(S966127) 33.819,12
PRIS m/ Elektronisk boks + depression controller	kr.	(S966163) 37.102,50	(S966164) 38.141,88

## MEDFØLGENDE STANDARD Udstyr XB 135 og XB 165



## PIC EPEICHE - Diamant bor Ø160mm med BRUSHLESS motor

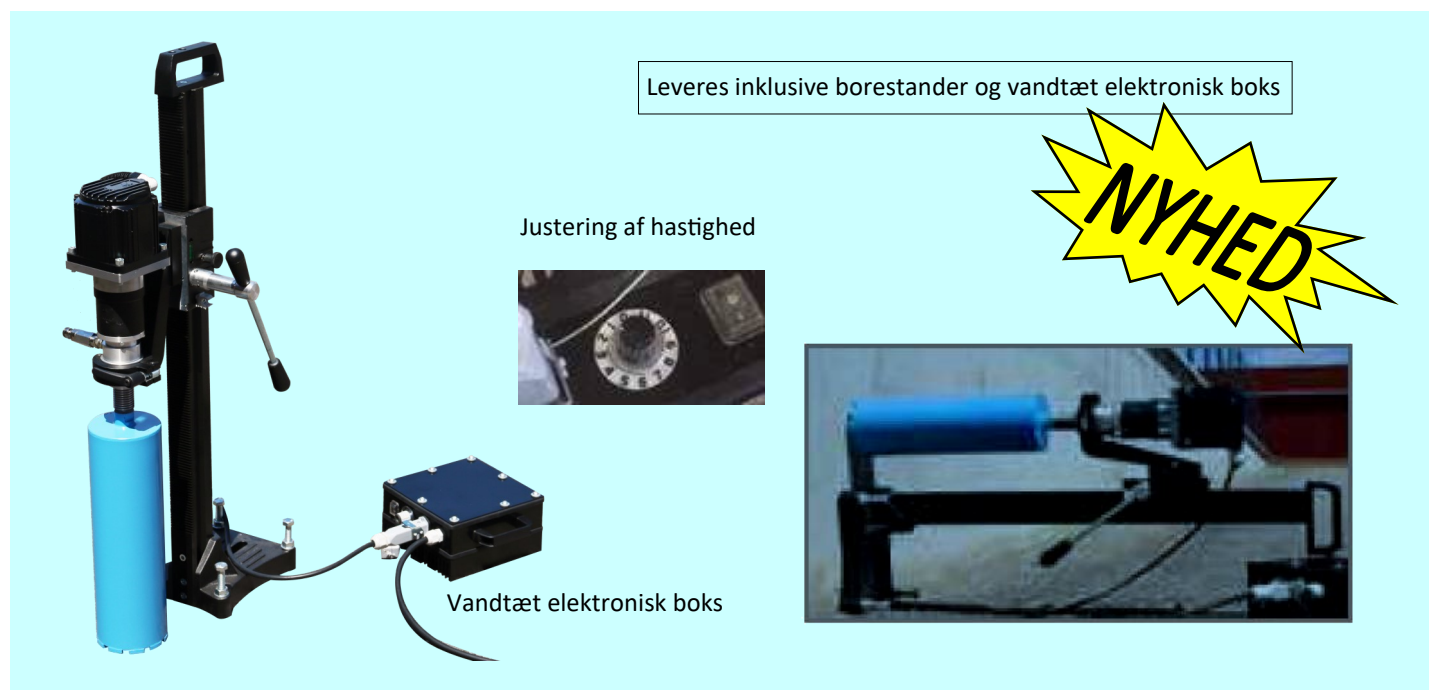

TEKNISKE SPECIFIKATIONER	PIC EPEICHE	
EFFEKT (230 V) output	W	1600
HASTIGHED SPEED 1 / SPEEED 2 / SPEED 3	rpm	400 / 550 / 700
VIBRATIONER	ms <sup>2</sup>	0.27
BESKYTTELSE		IP 64
DIAMETER KERNEBOR (MAX)	mm	160
MONTERING AF VÆRKTØJ		5/4" eller 1/2 GAS
VÆGT	Kg	15,5
PRIS m/ BRUSLESS motor	kr.	42.573,78
PRIS m/ BRUSLESS motor + depression controller m/ automatisk stop	Dkr.	46.897,56

## BRUSHLESS handheld crack chaser - TAUPE

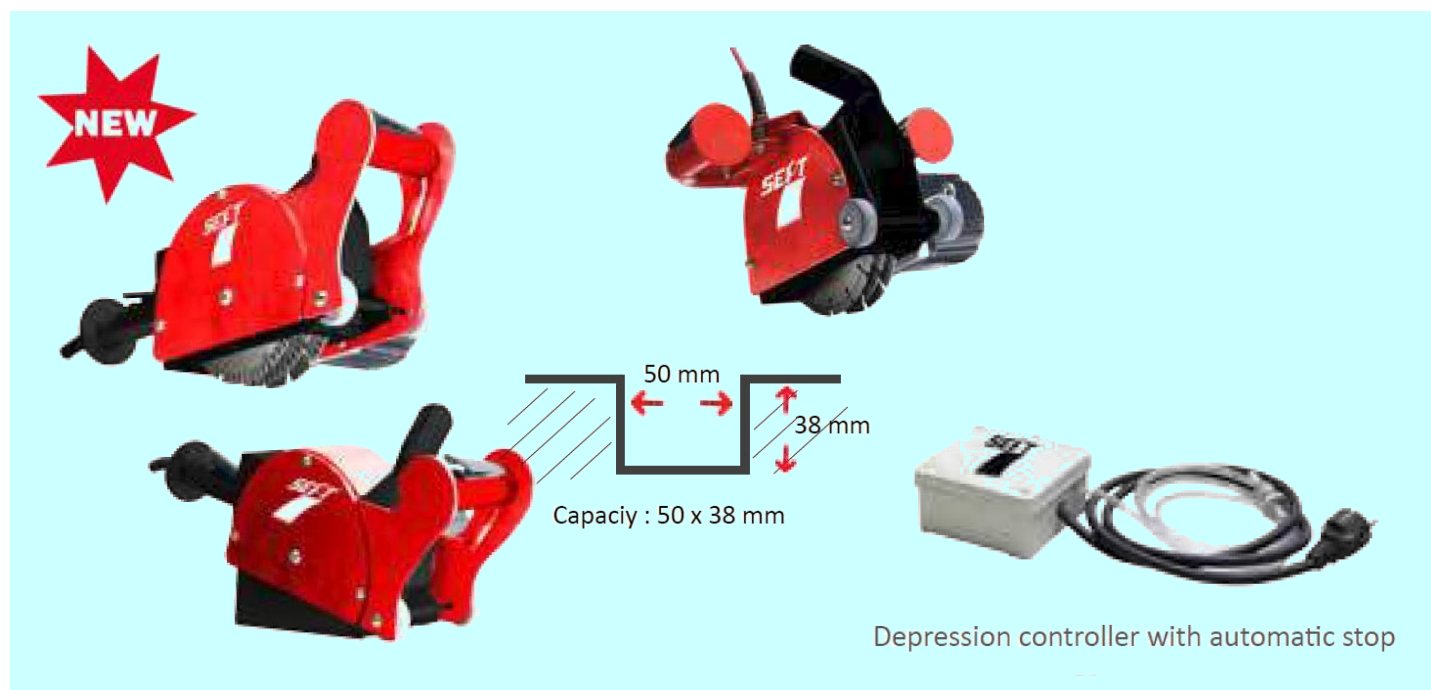

TEKNISKE SPECIFIKATIONER	TAUPE	
EFFEKT (230 V) output	W	1552
HASTIGHED SPEED 1 / SPEEED 2	rpm	2800 / 4800
VIBRATIONER	ms <sup>2</sup>	0.38
BESKYTTELSE		IP 64
LYDNIVEAU	dB	59
KLINGE	Ø / mm	200
SKÆREDYBDE (MAX)	mm	38
VÆGT	Kg	17
PRIS m/BRUSLESS motor og elektronisk boks	kr.	(S966177) 40.221,66
PRIS m/ BRUSLESS motor og elektronisk boks + depression controller m/ automatisk stop	kr.	44.545,44

**[INCISOR FS]**

- TurboStart (Selvskærpemde segmenter)
- Intensiv skæring
- Granit, beton, byggematerialer, flint, armeret beton, wirenetforstærket beton
- Specielt udviklet til kompakte materialer
- Hurtigt snit
- Højt output, høj ydeevne

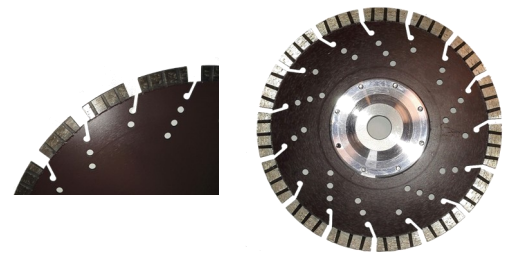

Incisor FS Ø230 m/flange

Ø	Hul	Varenr.	Kode	Pris Dkr
115	22,23	200331		kr. 734,40
125	22,23	200332		kr. 856,80
180	22,23	200333		kr. 1.126,08
230	22,23	200334		kr. 1.430,04
230	22,23	200330	m/ flange	kr. 1.583,04
300	20,0	200335		kr. 2.291,94
300	25,4	200336		kr. 2.291,94
350	20,0	200337		kr. 2.750,94
350	25,4	200338		kr. 2.750,94
400	20,0	200339		kr. 3.657,72
400	25,4	200340		kr. 3.657,72

**[PAP - PANTERA]**

- Alle byggematerialer
- Hurtig snit
- Universalklinge

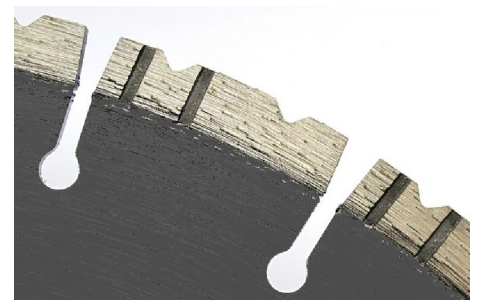
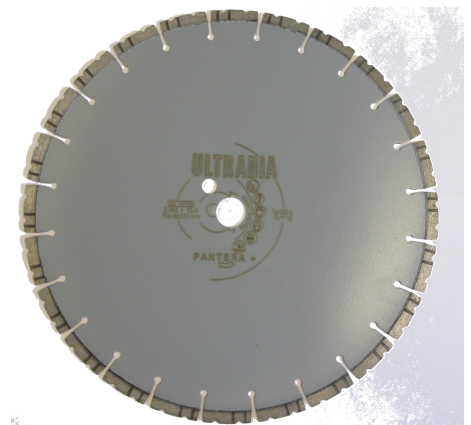

Ø	Hul	Varenr.	Antal Seg.	Segmentmål (l x h x b)	Kode	Pris Dkr
125	22,2	200010	10	30 x 10 x 2,4	PAPC001	kr. 538,56
150	22,2	200011	12	30 x 10 x 2,4	PAPC009	kr. 624,24
230	22,2	200012	16	38 x 10 x 2,6	PAPC002	kr. 844,56

**[Diaflex blå]**

- Armeret beton, flint beton, lintels
- Semi-abrasive materials, washed concrete
- Universalklinge

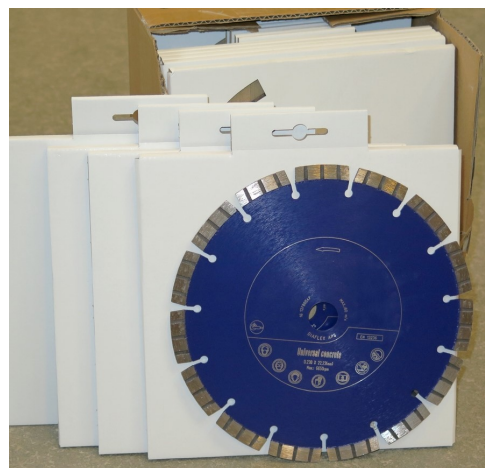

Ø	Hul	Varenr.	Segmentmål (l x h x b)	Kode	Pris Dkr
125	22,2	200450			kr. 257,04
230	22,2	200455			kr. 552,84
350	25,4	200460			kr. 1.240,32
400	25,4	200470			kr. 1.590,18

**[DIAFLEX Orange - TMS]**

- Limestone, betonfliser, mursten, letklinke-blokke  
Beton blokke, naturlig sandsten



Ø	Hul	Varenr.	Antal Seg.	Segmentmål (l x h x b)	Kode	Pris Dkr
350	25,4	203890	24	40 x 10 x 3,2	TMS1002	kr. 1.358,64
400	25,4	203891	28	40 x 10 x 3,2	TMS1003	kr. 1.697,28
450	25,4	203892	32	40 x 10 x 4,0	TMS1004	kr. 2.190,96

**[Diaflex Gul - MER]**

- Alle byggematerialer, cut in turn
- Lejlighedsvis skæring i granit
- Universalklinge



Ø	Hul	Varenr.	Antal Seg.	Segmentmål (l x h x b)	Kode	Pris Dkr
125	22,2	200194	9	33 x 10 x 2,2	MER1007	kr. 350,88
150	22,2	200195	9	40 x 10 x 2,4	MER1008	kr. 454,92
180	22,2	200196	11	40 x 10 x 2,4	MER1009	kr. 527,34
230	22,2	200197	16	40 x 10 x 2,4	MER1010	kr. 641,58





**[MMG]** 

- Alle byggematerialer
- Intensiv skæring i granit
- Præcist og hurtigt snit

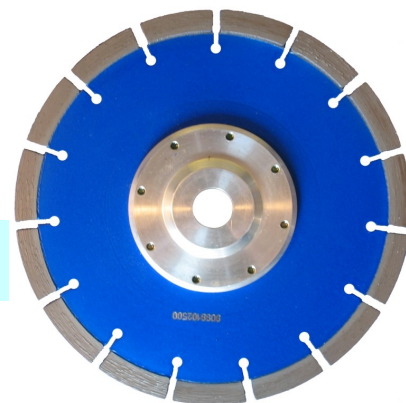
**KLINGE MED FLANGE FOR TÆTSKÆRING**

Ø	Hul	Varenr.	Antal Seg.	Segmentmål (l x h x b)	Pris Dkr
230	22,2	200043	16	40 x 13 x 2,6	kr. 1.595,28

**[Diamantklinge Concave ]** 

- Beton
- Buet klinge til at skære kurver

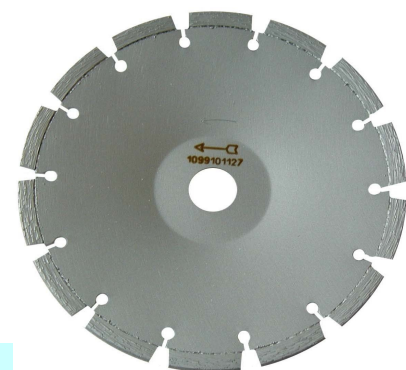
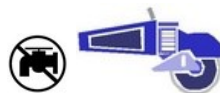

Ø	Hul	Varenr.	Antal Seg.	Segmentmål (l x h x b)	Pris Dkr
125	22,2	203103	14	20 x 7 x 2,2	kr. 1.044,48
180	22,2	203105	18	20 x 7 x 2,8	kr. 1.962,48

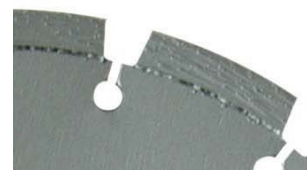
**[RAT - High Performance Silver]** 

- Rillefræsning
- Lintels, armeret beton, murværk, semi-abrasive materialer
- Hurtigt snit



Ø	Hul	Varenr.	Antal Seg.	Segmentmål (l x h x b)	Kode	Pris
125	22,2	200301	10	33 x 7,5 x 2,4	RAT1001	kr. 991,44
140	22,2	200302	11	33 x 7,5 x 2,4	RAT1002	kr. 881,28
150	22,2	200303	12	33 x 7,5 x 2,4	RAT1003	kr. 930,24
180	22,2	200304	12	40 x 7,5 x 2,4	RAT1004	kr. 1.211,76

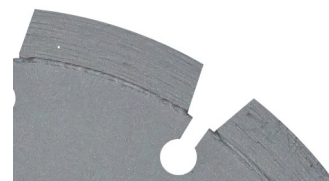

Leveres i pakker af 2 klinger. Den angivne pris er pr. klinge.

**[EJR - Crack Abrasive]** 

- Fjernelse af mørtel, rillefræsning i gulv, lægning af gulvvarme
- Abrasivt beton
- Højt output, høj ydeevne
- Vertikale segmenter for beskyttelse af stambladet
- Snitbredde: 7,5mm



Ø	Hul	Varenr.	Antal Seg.	Segmentmål (l x h x b)	Kode	Pris
125	22,2	200442	6	40 x 7,5 x 7,5	EJR0004	kr. 1.978,80

**[EJC - Crack Compact]** 

- Fjernelse af mørtel, rillefræsning i gulv, lægning af gulvvarme
- Hårdt beton, tæt beton
- Høj skærehastighed, høj ydeevne
- Vertikale segmenter for beskyttelse af stambladet
- Snitbredde: 7,5mm



Ø	Hul	Varenr.	Antal Seg.	Segmentmål (l x h x b)	Kode	Pris
125	22,2	200502	6	40 x 7,5 x 7,5	EJC0006	kr. 1.627,92

**[EJF - Easy Cut Gold]** 

- Bearbejdning af murværk, fjernelse af mørtel, skærer mursten
- Forskudte segmenter
- Hurtigt snit
- Vertikale segmenter for beskyttelse af stambladet
- Snitbredde: 7,5mm



Ø	Hul	Varenr.	Antal Seg.	Segmentmål (l x h x b)	Kode	Pris
125	22,2	200405	12	20 x 7,5 x 3,6	EJF0005	kr. 1.415,76

## [TAS - Beton Dark Grey]

- Universel beton, murværk, kantsten, overliggere
- Hurtig, let skæring
- Høj ydelse

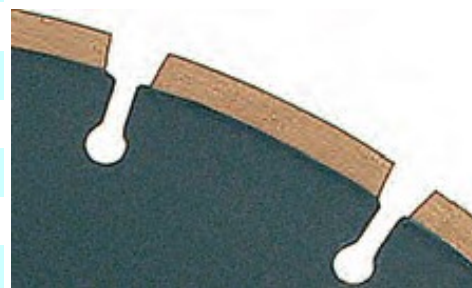
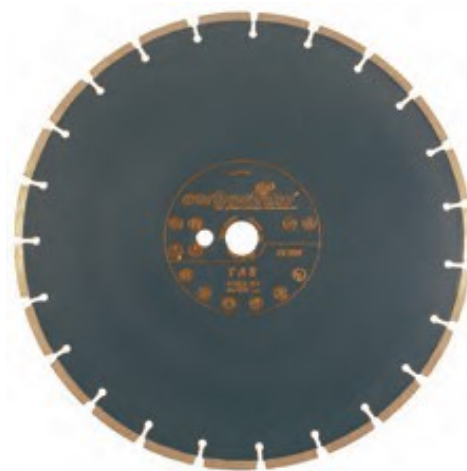

Ø	Hul	Varenr.	Antal Seg.	Segmentmål (h x b)	Kode	Pris Dkr
300	25,4/20	203851	18	40 x 13 x 2,8	TAS1301	kr. 1.513,68
350	25,4/20	203853	21	40 x 13 x 3,0	TAS1302	kr. 1.840,08
400	25,4	203854	24	40 x 13 x 3,2	TAS1303	kr. 2.162,40
450	25,4	203855	25	40 x 13 x 3,6	TAS1304	kr. 2.578,56
500	25,4	203856	30	40 x 13 x 3,6	TAS1305	kr. 4.051,44
600	25,4	203857	34	40 x 13 x 3,6	TAS1306	kr. 4.749,12
650	25,4	203858	36	40 x 13 x 3,6	TAS1307	kr. 5.742,60
700	25,4	203859	40	40 x 13 x 3,6	TAS1308	kr. 7.160,40

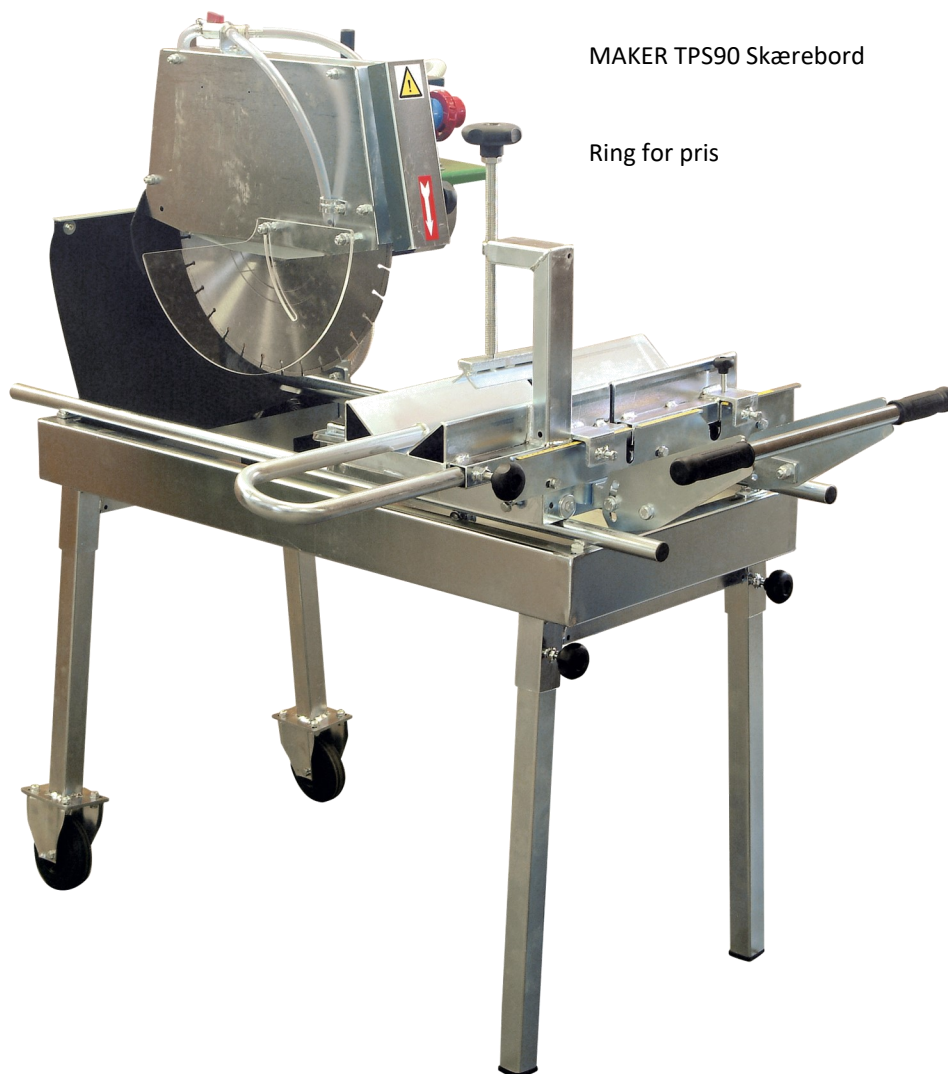

MAKER TPS90 Skærebord

Ring for pris

**[DIAFLEX Orange - TMS]**

- Limestone, betonfliser, mursten, letklinke-blokke  
Beton blokke, naturlig sandsten



Ø	Hul	Varenr.	Antal Seg.	Segmentmål (l x h x b)	Kode	Pris Dkr
350	25,4	203890	24	40 x 10 x 3,2	TMS1002	kr. 1.358,64
400	25,4	203891	28	40 x 10 x 3,2	TMS1003	kr. 1.697,28
450	25,4	203892	32	40 x 10 x 4,0	TMS1004	kr. 2.190,96

**[TME - Masonry Orange]**

- Limestone, betonfliser, mursten, letklinke-blokke  
Beton blokke, naturlig sandsten

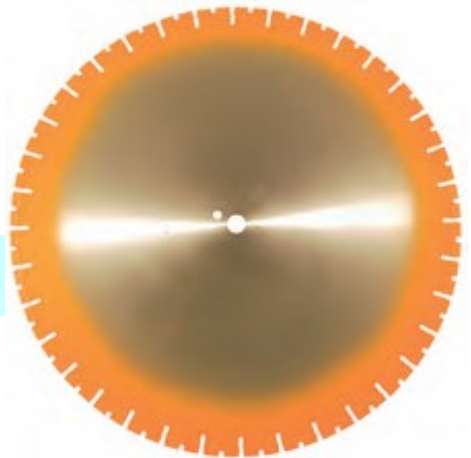

Ø	Hul	Varenr.	Antal Seg.	Segmentmål (l x h x b)	Kode	Pris Dkr
500	25,4	203901	36	40 x 10 x 4,0	TME1001	kr. 3.745,44
600	24,4	203902	42	40 x 10 x 4,5	TME1002	kr. 4.451,28
650	25,4	203903	45	40 x 10 x 4,5	TME1003	kr. 5.426,40
700	25,4	203904	49	40 x 10 x 4,5	TME1004	kr. 6.956,40
900	25,4	203905	60	40 x 10 x 4,5	TME1005	kr. 11.203,68
1000	25,4	203906	70	40 x 10 x 5,0	TME1006	kr. 15.136,80

**MAKER TS-450 gulvsav  
med Honda GX390 Benzin 9,3KW**

- Stål vandtank, 60 L
- Ø450 klinge \*
- Skæredybde 165mm
- Manuel skæredybde justeres med det kraftige håndsving

TS450 er kompakt maskine, der er let at manøvrere  
Den er perfekt til skærearbejde i meget små områder, med henblik på at skære kanaler for installation af rør, el- og telefonkabler i asfalt og beton overflader..



kr. 21730,08  
Eksklusive klinge

**[BHL - Abrasive Beton Emerald Green]**

- Abrasive beton, sandsten, betonfliser, mursten, schamotte
- Mixed asfalt / beton applications



Ø	Hul	Varenr.	Antal Seg.	Segmentmål (l x h x b)	Kode	Pris Dkr
300	25,4+T	200213	18	42 x 13 x 2,8	BHL1303	kr. 1.844,16
300	25,4+T	200214	20	42 x 13 x 2,8	BHL1304	kr. 1.995,12
350	25,4+T	200217	21	40 x 13 x 3,0	BHL1307	kr. 2.509,20
350	25,4+T	200218	24	40 x 13 x 3,0	BHL1308	kr. 2.460,24
400	25,4+T	200220	24	40 x 13 x 3,2	BHL1310	kr. 2.677,50

**[JBT - Tile Cutter Grey]**

- Keramik, tætte klinker, vitrificerede klinker, porcelæn, hård marmor
- Præcist snit



Ø	Hul	Varenr.	Segmentmål (h x b)	Kode	Pris Dkr
125	22,2	202703	6 x 1,6	JBT0003	kr. 398,82
150	22,2	202704	6 x 1,6	JBT0004	kr. 642,60
180	22,2	202705	6 x 1,6	JBT0005	kr. 642,60
200	30,0/25,4	202706	6 x 1,6	JBT0006	kr. 791,52
230	22,2	202707	6 x 1,6	JBT0007	kr. 1.170,96
250	30,0/25,4	202708	6 x 1,6	JBT0008	kr. 1.170,96
300	30,0/25,4	202709	7 x 2,0	JBT0009	kr. 1.323,96
350	30,0/25,4	202710	7 x 2,2	JBT0010	kr. 1.705,44

## [JTC - Thin Turbo Tile Cutter]

- Keramik, tætte klinker, hård marmor, hårde vitrificerede produkter
- Intensiv skæring
- Ekstra tynd

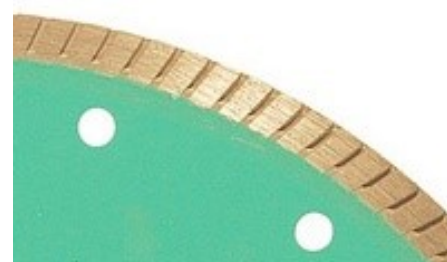

Ø	Hul	Varenr.	Segmentmål (h x b)	Kode	Pris Dkr
125	22,2	202782	7 x 1,2	JTC4002	kr. 379,44
150	22,2	202783	7 x 1,6	JTC4003	kr. 485,52
180	22,2	202784	7 x 1,6	JTC4004	kr. 550,80
200	22,2	202785	7 x 1,6	JTC4005	kr. 693,60
230	22,2	202786	7 x 1,6	JTC4006	kr. 832,32
250	30/25,4	202787	7 x 1,6	JTC4007	kr. 1.064,88
300	30/25,4	202788	7 x 2,0	JTC4008	kr. 1.578,96
350	30/25,4	202789	7 x 2,2	JTC4009	kr. 1.933,92

## [JCT - Tile Cutter Navy Blue]

- Terracotta, klinker, granit
- Præcist snit



Ø	Hul	Varenr.	Segmentmål (h x b)	Kode	Pris Dkr
125	22,2	202743	6 x 1,6	JCT0003	kr. 399,84
150	22,2	202744	6 x 1,6	JCT0004	kr. 644,64
180	22,2	202745	6 x 1,6	JCT0005	kr. 644,64
200	30,0/25,4	202746	6 x 1,6	JCT0006	kr. 791,52
230	22,2	202747	6 x 1,6	JCT0007	kr. 1.170,96
250	30,0/25,4	202748	6 x 1,6	JCT0008	kr. 1.170,96
305	30,0/25,4	202749	7 x 2,0	JCT0009	kr. 1.326,00
355	30,0/25,4	202750	7 x 2,2	JCT0010	kr. 1.705,44

### [APS 13 - Black Intensive]

- Asfaltklinge (Abrasive materialer)
- Højt output, lang levetid
- "DEEP" segmenter beskytter stambladet

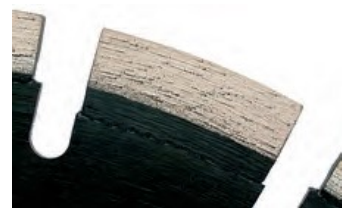

Ø	Hul	Varenr.	Antal Seg.	Segmentmål (l x h x b)	Kode	Pris Dkr
300	20	200601	18	42 x 13 x 2,8	APS1301	kr. 2.617,00
350	25,4+T	200606	21	40 x 13 x 3,0	APS1302	kr. 3.174,00
400	25,4+T	200609	24	40 x 13 x 3,2	APS1303	kr. 4.080,00

### [VLA/BPH - Vega Abrasive]

- Asfalt, abrasivt beton (semi-abrasive materialer)
- Universalklinge til gulvarbejde



Ø	Hul	Varenr.	Segmentmål (l x h x b)	Pris Dkr
300	20	200692	38 x 10 x 3,2	kr. 1.489,20
300	25,4	200693	38 x 10 x 3,2	kr. 1.489,20
350	20	200695	38 x 10 x 3,2	kr. 1.876,80
350	25,4	200743	38 x 10 x 3,2	kr. 1.876,80
400	20	200698	38 x 10 x 3,5	kr. 2.272,56
400	25,4	200744	38 x 10 x 3,5	kr. 2.272,56
450	25,4	200745		kr. 3.031,44

**[INCISOR FS]**

- TurboStart (Selvskærpnde segmenter)
- Intensiv skæring
- Granit, beton, byggematerialer, flint, armeret beton, metal-sektioner, jern, stål, wirenetforstærket beton
- Hurtigt snit
- Højt output, høj ydeevne

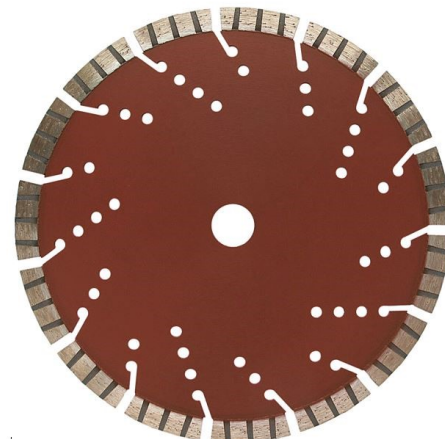

Ø	Hul	Varenr.	Segmentmål (l x h x b)	Pris Dkr
300	20	200335		kr. 2.291,94
300	25,4	200336		kr. 2.291,94
350	20	200337		kr. 2.750,94
350	25,4	200338		kr. 2.750,94
400	20	200339		kr. 3.657,72
400	25,4	200340		kr. 3.657,72

**[BHL - Abrasive Concrete Emerald Green]**

- Beton (abrasive aggregates)
- Mixed asfalt / beton opgaver
- Laser



Ø	Hul	Varenr.	Antal Seg.	Segmentmål (l x h x b)	Kode	Pris Dkr
300	20	200211	18	42 x 13 x 2,8	BHL1301	kr. 1.844,16
300	25,4+T	200213	18	42 x 13 x 2,8	BHL1303	kr. 1.844,16
300	20	200212	20	42 x 13 x 2,8	BHL1302	kr. 1.995,12
300	25,4+T	200214	20	42 x 13 x 2,8	BHL1304	kr. 1.995,12
350	20	200215	21	40 x 13 x 3,0	BHL1305	kr. 2.382,72
350	25,4+T	200217	21	40 x 13 x 3,0	BHL1307	kr. 2.382,72
350	20	200216	24	40 x 13 x 3,0	BHL1306	kr. 2.460,24
350	25,4+T	200218	24	40 x 13 x 3,0	BHL1308	kr. 2.460,24
400	20	200219	24	40 x 13 x 3,2	BHL1309	kr. 2.680,56
400	25,4+T	200220	24	40 x 13 x 3,2	BHL1310	kr. 2.680,56





**[PANTERA]** 

- Alle byggematerialer
- Intensiv skæring i granit
- Universalklinge

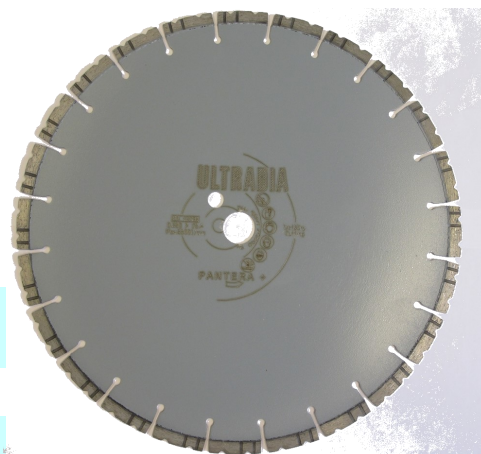

Ø	Hul	Varenr.	Antal Seg.	Segmentmål (l x h x b)	Kode	Pris Dkr
300	20	200016	20	38 x 10 x 2,8	PAP0003	kr. 1.538,16
300	25,4	200013	20	38 x 10 x 2,8	PAP0004	kr. 1.538,16
350	20	200017	24	38 x 10 x 3,2	PAP0005	kr. 1.978,80
350	25,4	200014	24	38 x 10 x 3,2	PAP0006	kr. 1.978,80
400	20	200018	28	38 x 10 x 3,2	PAP0007	kr. 2.513,28
400	25,4	200015	28	38 x 10 x 3,2	PAP0008	kr. 2.513,28

**[Diaflex blå]**



- Armeret beton, flint beton, lintels
- Semi-abrasive materials, washed concrete
- Universalklinge

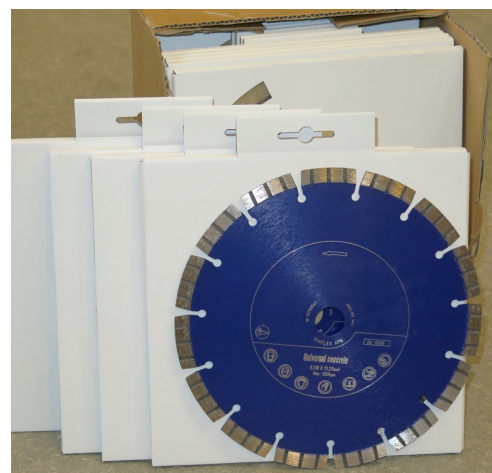

Ø	Hul	Varenr.	Pris Dkr
350	25,4	200460	kr. 1.240,32
400	25,4	200470	kr. 1.590,18

**[AZE - High Performance Asphalt]**

- TurboStart (Selv-skærpnde segmenter)
- Asfaltklinge (Abrasive til semi-abrasive materialer)
- "DEEP"-segmenter beskytter stambladet



Ø	Varenr.	Antal Seg.	Segmentmål (l x h x b)	Kode	N <sup>0</sup> Prot.	Pris Dkr
500	201030	36	40 x 10 x 3,9	AZE1012	6	kr. 9.359,52
600	201031	42	40 x 10 x 3,9	AZE1001	6	kr. 11.134,32
600	201032	42	40 x 10 x 4,5	AZE1002	6	kr. 11.550,48
650	201033	46	40 x 10 x 3,9	AZE1003	6	kr. 12.815,28
650	201034	46	40 x 10 x 4,5	AZE1004	6	kr. 13.268,16
700	201035	50	40 x 10 x 4,5	AZE1005	6	kr. 14.124,96
750	201036	54	40 x 10 x 4,5	AZE1006	8	kr. 15.703,92
800	201037	57	40 x 10 x 4,5	AZE1007	8	kr. 16.646,40
900	201040	52	40 x 10 x 4,5	AZE1010	8	kr. 19.229,04
900	201038	64	40 x 10 x 4,5	AZE1008	8	kr. 21.077,28
1000	201041	58	40 x 10 x 4,5	AZE1011	8	kr. 22.219,68
1000	201039	70	40 x 10 x 4,5	AZE1009	10	kr. 24.072,00

Oplys centerhul og pin huller

**[AHE - High Output Asphalt Black]**

- TurboStart (Selv-skærpnde segmenter)
- Asfaltklinge (Abrasive til semi-abrasive materialer)
- "DEEP"-segmenter beskytter stambladet



Ø	Varenr.	Antal Seg.	Segmentmål (l x h x b)	Kode	N <sup>0</sup> Prot.	Pris Dkr
600	201020	36	40 x 7,5 x 3,9	AHE0003	4	kr. 9.037,20
600	201023	36	40 x 7,5 x 4,5	AHE0004	4	kr. 9.265,68
650	201024	38	40 x 7,5 x 3,9	AHE0013	4	kr. 9.755,28
650	201026	38	40 x 7,5 x 4,5	AHE0014	4	kr. 9.996,00
700	201025	40	40 x 7,5 x 4,5	AHE0005	5	kr. 10.824,24
800	201027	46	40 x 7,5 x 4,5	AHE0006	6	kr. 12.664,32

## [AHS - High Output Asphalt Black]

- TurboStart (Selv-skærpnde segmenter)
- Asfaltklinge (Abrasive til semi-abrasive materialer)
- "DEEP"-segmenter beskytter stambladet



Ø	Varenr.	Hul	Antal Seg.	Segmentmål (l x h x b)	N <sup>o</sup> Prot.	Kode	Pris Dkr
300	201050	20	18	40 x 10 x 3,2	3	AHS0012	kr. 3.080,40
300	201052	25,4+T	18	40 x 10 x 3,2	3	AHS0002	kr. 3.080,40
350	201053	20	21	40 x 10 x 3,2	3	AHS0013	kr. 3.463,92
350	201054	25,4+T	21	40 x 10 x 3,2	3	AHS0004	kr. 3.463,92
400	201055	25,4+T	24	40 x 10 x 3,6	3	AHS0005	kr. 4.940,88
450	201057	25,4+T	26	40 x 10 x 3,6	4	AHS0007	kr. 5.610,00
500	201059	25,4+T	30	40 x 10 x 3,6	5	AHS0009	kr. 6.711,60

## [APS 13 - Black Intensive]





- Asfaltk (Abrasive aggregates)
- "DEEP"-segmenter beskytter stambladet





Ø	Varenr.	Hul	Antal Seg.	Segmentmål (l x h x b)	N <sup>o</sup> Prot.	Kode	Pris Dkr
350	200606	25,4+T	21	40 x 13 x 3,0	3	APS1302	kr. 3.174,00
400	200609	25,4+T	24	40 x 13 x 3,2	4	APS1303	kr. 4.080,00
450	200610	25,4+T	25	40 x 13 x 3,6	5	APS1304	kr. 4.920,00
500	200611	25,4+T	30	40 x 13 x 3,6	5	APS1305	kr. 6.241,00
600	200615	25,4+T	35	40 x 13 x 4,0	5	APS1306	kr. 7.594,00



## Floor Saws

Varenr.	<b>MAKER</b> <small>S.r.l.</small>	BETON & ASFALT GULVSAVE	Kg.	Pris DKK.
		<b>TS300</b> Plastik vandtank og manuel fremdrift Ø350 mm, skæredybde max 125 mm, 10L vandtank		
M010701		KOHLER CH270 Petrol Engine, 5,2 KW	59	kr. 14.137,20
M010702		HONDA GX160 Petrol Engine, 4,0 KW	57	kr. 15.021,54
M010703		1PHASE V230-50Hz Electric Engine, 2,2 KW	54	kr. 13.607,82
<p>TS300 MAKER Gulvsav er enkel, let, robust og let at manøvrere og at transportere. Perfekt til skærearbejde i snævre rum. Håndtaget er justerbar og foldbart for at lette transport og manøvrering, selv for en enkel person. Skærings dybde kan indstilles i alle positioner ved håndsving. Vandtanken på 10 liter er aftagelig uden brug af værktøj. Front sværet er komplet med index for snit retning. Frem-stop sikkerhedsanordning, der standser bladets rotation.</p>				
		<b>TS350</b> Plastik vandtank og manuel fremdrift Ø350 mm, Skæredybde max 125 mm, 30L vandtank		
M010102		KOHLER CH395 Petrol Engine, 7,1 KW	100	kr. 17.671,50
M010104		HONDA GX270 Petrol Engine, 6,6 KW	98	kr. 19.085,22
M010105		15LD350 LOMBARDINI Diesel Engine, 5,5 KW	100	kr. 25.094,04
M010106	3PHASE V400-50Hz Electric Engine, 4,0 KW	92	kr. 16.081,32	
<p>TS350 MAKER Gulvsav er en kompakt maskine, der er let at manøvrere. Den er perfekt til skærearbejde i meget små områder, med henblik på at skære kanaler for installation af rør, el- og telefonkabler i asfalt og beton overflader. Takket være dens kompakte vægt, er den let at transportere, men stadig sikker og robust. Maskine er udstyret med god motorkraft som sikrer høj ydeevne. Manuel skæredybde justeres med håndsving. Komplet med plastic vandtank 30 liter for køling af diamantklinge. Muligheden for at et stort udvalg af motorer (benzin, elektrisk og diesel) for opfylde alle krav til skæring indenfor og udendørs.</p>				
		<b>TS450</b> Plastik vandtank og manuel fremdrift Ø500mm, Skæredybde max 185 mm, 30L vandtank		
M8103A002		KOHLER CH440 Petrol Engine, 10,5 KW	112	kr. 19.085,22
M010804		HONDA GX390 Petrol Engine, 9,6 KW	110	kr. 20.322,48
M010805		ROBIN SUBARU EH41 Petrol Engine, 10,0 KW	110	kr. 19.969,56
M010806		15LD440 AE LOMBARDINI Diesel Engine, 8,1 KW	122	kr. 31.808,70
M010807	3PHASE V400-50Hz Electric Engine, 4,0 KW	96	kr. 17.142,12	
<p>TS450 MAKER Gulvsav er en kompakt maskine, der er let at manøvrere. Den er perfekt til skærearbejde i meget små områder, med henblik på at skære kanaler for installation af rør, el- og telefonkabler i asfalt og beton overflader. Takket være dens kompakte vægt, er den let at transportere, men stadig sikker og robust. Maskine er udstyret med god motorkraft som sikrer høj ydeevne. Manuel skæredybde justeres med håndsving. Komplet med plastic vandtank 30 liter for køling af diamantklinge. Muligheden for at et stort udvalg af motorer (benzin, elektrisk og diesel) for opfylde alle krav til skæring indenfor og udendørs.</p>				

## Floor Saws

Varenr.	<b>MAKER</b> <small>S.A.L.</small>	<b>BETON &amp; ASFALT GULVSAVE</b>	Kg.	Pris DKK.
		<b>TS140</b> Stålvandtank og semiautomatisk fremdrift med håndsving. Ø500 mm, Skæredybde max 185 mm, 50L vandtank		
M8104A001		KOHLER CH440 Petrol Engine, 10,5 KW	167	kr. 25.446,96
M010205		HONDA GX390 Petrol Engine, 9,6 KW	165	kr. 27.745,02
M010206		ROBIN SUBARU EH41 Petrol Engine, 10,0 KW	161	kr. 27.214,62
M010211		15LD440 AE LOMBARDINI Diesel Engine, 8,1 KW	186	kr. 41.528,28
M010209		3PHASE V400-50Hz Electric Engine, 5,5 KW	151	kr. 22.973,46
<p>TS140 Maker er fremstillet til skæring i asfalt og beton. Den er robust, kompakt og let at manøvrere. Særlig velegnet til skæreeopgaver i mindre og mellemstore overflader såsom beton industrigulve og asfalt vejarbejde. Manuel skæredybde justeres med håndsving. Komplet med stålvandtank 50 liter for køling af diamantklænge. Muligheden for at et stort udvalg af motorer (benzin, elektrisk og diesel) for opfylde alle krav til skæring indenfor og udendørs. TS140 kan leveres med hydraulik til manuel justering af skæredybde.</p>				
		<b>TS160</b> Stålvandtank og semiautomatisk fremdrift med håndsving. Ø500mm, Skæredybde max 190 mm, 60L vandtank		
M010302		HONDA GX390 Petrol Engine 9,6 KW	204	kr. 32.028,00
M010303		ROBIN SUBARU EH41 Petrol Engine, 10,0 KW	204	kr. 31.287,48
M010309		15LD500 AE LOMBARDINI Diesel Engine, 8,8 KW	236	kr. 49.059,96
M010308		3PHASE V400-50Hz Electric Engine, 7,5	214	kr. 28.139,76
<p>TS160 MAKER Gulvsav er udviklet til skæring af industrigulve, skæring af dilatationsfuger og til reparation af enhver type af betonoverflader. Velegnet for virksomheder der udfører asfalkæring hvor det er nødvendigt med en høj ydeevne. Manuel skæredybde justeres med håndsving. 60 liter Stålvandtank med hermetisk låg og særlig antistøj og korrosionsbeskyttelse. Den elektriske version er med dobbelt isolering komplet med stik - stik og afbryder er med termisk Safe-Motor. TS160 kan leveres forberedt til Ø600 mm klinger / 25,4 mm med mulighed for en max. skæredybde på 240 mm.</p>				
		<b>TS180</b> Stålvandtank og semiautomatisk fremdrift med håndsving. Ø600 mm, Skæredybde max 240 mm, 60L vandtank		
M010401		HONDA GX630 Petrol Engine (2 cylindere), 15,5 KW	255	kr. 61.833,42
M010406		ROBIN SUBARU EH64 Petrol Engine (2 cylindere), 15,4 KW	255	kr. 61.092,90
M010404		12LD477.2 AE LOMBARDINI Diesel Engine (2 cylindere) 17,0 KW	298	kr. 74.978,16
M010405		3PHASE V400-50Hz Electric Engine, 9,2 KW	214	kr. 54.428,22
<p>TS180 MAKER Gulvsav er udviklet til skæring af industrigulve og brolægge, der ønsker høj kraftoverførsel for at opnå en hurtig og præcis snit. Velegnet for virksomheder der udfører asfalkæring hvor det er store og mellemstore opgaver. Skæredybde justeres med manuel hydraulikpumpe. 60 liter Stålvandtank med hermetisk låg og særlig antistøj og korrosionsbeskyttelse. Et særligt femte hjul giver mulighed for hurtige ændringer. Den elektriske version er med dobbelt isolering komplet med stik - stik og afbryder er med termisk Safe-Motor.</p>				
M1601A098 M6310A006	TS160 og TS180 kan monteres med KIT for Automatisk fremdrift			Ring for pris

## Floor Saws

Varenr.	<b>MAKER</b> <small>s.r.l.</small>	BETON & ASFALT GULVSAVE	Kg.	Pris DKK.
		<b>TS200</b>	Stål vandtank og automatisk fremdrift med Hydraulisk shifter Ø700 til 1000mm, Skæredybde max 270 mm, 80L vandtank	
M010501		Lambordini 9LD625.2 Diesel - Ø700mm 18,8kW / 25,6HP	534	Ring for pris
M010503		Lambordini 9LD625.2 Diesel - Ø900/1000mm 18,8kW / 25,6HP	570	Ring for pris
M010502		3PHASE 400V-50Hz - Ø700mm 15,0kW / 20,0HP	458	Ring for pris
1302A002		OPTION: Skærm for klinge Ø900 (H=370)		Ring for pris
		<b>TS250</b>	Stål vandtank og automatisk fremdrift med Hydraulisk shifter Ø1000mm, Skæredybde max 410 mm, 80L vandtank	
M010601		Lambordini 5LD825.2 A.E. Diesel - 25,0kW / 34,0HP	660	Ring for pris
M010602		3PHASE 400V-50Hz - Ø700mm 15,0kW / 20,0HP	630	Ring for pris
M010603		3PHASE 400V-50Hz - Ø700mm 22,0kW / 30,0HP	640	Ring for pris
1302A0145		OPTION: Skærm for klinge Ø1200 (H=500)		Ring for pris

[BVE - Alligator 22 HP] 

- TurboStart (Selv-skærpende segmenter)
- Buer på siden af segmenterne
- Meget gammelt, tæt og armeret beton
- Meget hurtigt snit

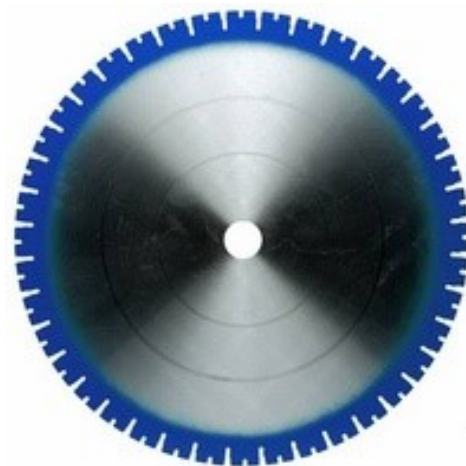

Ø	Hul	Varenr.	Antal Seg.	Segmentmål (l x h x b)	Kode	Pris Dkr
450	25,4	204825	26	46 x 10 x 3,9	BVE0040	kr. 6.026,16
450	60,0	204826	26	46 x 10 x 3,9	BVE0040	kr. 6.026,16
500	25,4	204827	30	46 x 10 x 3,9	BVE0027	kr. 6.850,32
500	60,0	204828	30	46 x 10 x 3,9	BVE0027	kr. 6.850,32
600	25,4	204831	36	46 x 10 x 3,9	BVE0030	kr. 8.204,88
600	60,0	204832	36	46 x 10 x 3,9	BVE0030	kr. 8.204,88
650		204835	38	46 x 10 x 3,9	BVE0033	kr. 9.004,56
700	25,4	204871	40	46 x 10 x 3,9	BVE0054	kr. 9.432,96
700	60,0	204872	40	46 x 10 x 3,9	BVE0054	kr. 9.432,96
750		204875	42	46 x 10 x 4,2	BVE0048	kr. 10.665,12
800		204879	46	46 x 10 x 4,2	BVE0050	kr. 11.346,48
900		204853	52	46 x 10 x 4,2	BVE0051	kr. 14.377,92
1000		204883	58	46 x 10 x 4,2	BVE0052	kr. 16.952,40
1200		204886	68	46 x 10 x 4,2	BVE0053	kr. 21.889,20

Oplys centerhul og pin huller

## SUNDT GS675 gulvsav

kr. 53.366,40

Eksklusive klinge

- 7,5kW
- 400V
- Ø600
- Skæredybde 250mm
- 112 kg



**Sundt 675 gulvsav** er en robust klassisk gulvsavsmaskine med mange års succesfuld drift under de hårdeste forhold. Gulvsaven er den perfekte løsning til mindre arbejdsopgaver og et begrænset budget, men uden at gå på kompromis med kvaliteten. **Gulvsaven er smart modulær** Gulvsaven har en veldesignet modulstruktur, som giver den højest mulige mobilitet. Du kan skifte mellem venstre og højre kryds. Gulvsaven har en trinløs cutter indstilling.

## [BTL - High Performance Concrete]

- Armeret beton, self-locking cobbelstones, washed flint tiles



Ø	Hul	Varenr.	Antal Seg.	Segmentmål (l x h x b)	Kode	Pris Dkr
350	25,4+T	201906	21	40 x 13 x 3,0	BTL1304	kr. 2.680,56
400	25,4+T	201909	24	40 x 13 x 3,2	BTL1306	kr. 3.386,40
450	25,4+T	201911	25	40 x 13 x 3,6	BTL1307	kr. 3.814,80
500	25,4+T	201913	30	40 x 13 x 3,6	BTL1308	kr. 4.235,04
600	25,4+T	201915	34	40 x 13 x 3,6	BTL1309	kr. 4.977,60
700	25,4+T	201917	40	40 x 13 x 3,6	BTL1310	kr. 7.588,80
750	25,4+T	201919	42	40 x 13 x 3,6	BTL1311	kr. 8.588,40
800	25,4+T	201921	46	40 x 13 x 3,6	BTL1312	kr. 9.979,68
900	25,4+T	201923	56	40 x 13 x 3,6	BTL1313	kr. 15.871,20



## SUNDT GS800 gulvsav

- 7.5kW
- 400V
- Ø800
- Skæredybde 320mm
- 185 kg

kr. 65.932,80  
Eksklusive klinge





## [ABR - Grooving]

- Rillefræsning af abrasivt beton og asfalt (kabel lægning).  
mørtel rivning af beton gulve
- Brede mellemrum mellem segmenterne giver højt output
- Kabel lægning
- Kan leveres i flere bredder



**15 - 35 HP**



Ø	Hul	Varenr.	Antal Seg.	Segmentmål (l x h x b)	Kode	Pris Dkr
300	25,4	200351	18	40 x 6 x 6	ABR0001	kr. 6.042,48
300	25,4	200353	18	40 x 6 x 8	ABR0003	kr. 6.442,32
300	25,4	200354	18	40 x 6 x 10	ABR0004	kr. 6.813,60
300	25,4	200355	18	40 x 6 x 12	ABR0005	kr. 7.188,96
300	25,4	200356	18	40 x 6 x 15	ABR0006	kr. 7.764,24
350	25,4	200357	21	40 x 6 x 6	ABR0007	kr. 6.838,08
350	25,4	200359	21	40 x 6 x 8	ABR0009	kr. 7.303,20
350	25,4	200360	21	40 x 6 x 10	ABR0010	kr. 7.743,84
350	25,4	200361	21	40 x 6 x 12	ABR0011	kr. 8.180,40
350	25,4	200362	21	40 x 6 x 15	ABR0012	kr. 8.849,52
400	25,4	200363	24	40 x 6 x 6	ABR0013	kr. 7.841,76
400	25,4	200365	24	40 x 6 x 8	ABR0015	kr. 8.376,24
400	25,4	200366	24	40 x 6 x 10	ABR0016	kr. 8.874,00
400	25,4	200367	24	40 x 6 x 12	ABR0017	kr. 9.371,76
400	25,4	200368	24	40 x 6 x 15	ABR0018	kr. 10.142,88
450	25,4	200369	26	40 x 6 x 6	ABR0019	kr. 8.698,56
450	25,4	200370	26	40 x 6 x 8	ABR0020	kr. 9.277,92
450	25,4	200371	26	40 x 6 x 10	ABR0021	kr. 9.816,48
450	25,4	200372	26	40 x 6 x 12	ABR0022	kr. 10.359,12
450	25,4	200373	26	40 x 6 x 15	ABR0023	kr. 11.191,44
500	25,4	200374	30	40 x 6 x 6	ABR0024	kr. 10.175,52
500	25,4	200375	30	40 x 6 x 8	ABR0025	kr. 10.844,64
500	25,4	200376	30	40 x 6 x 10	ABR0026	kr. 11.468,88
500	25,4	200377	30	40 x 6 x 12	ABR0027	kr. 12.089,04
500	25,4	200378	30	40 x 6 x 15	ABR0028	kr. 13.051,92

**[BBR - Grooving]**

- Rillefræsning af beton
- Brede mellemrum mellem segmenterne giver højt output
- Kabellægning m.m.
- Kan leveres i flere bredder.

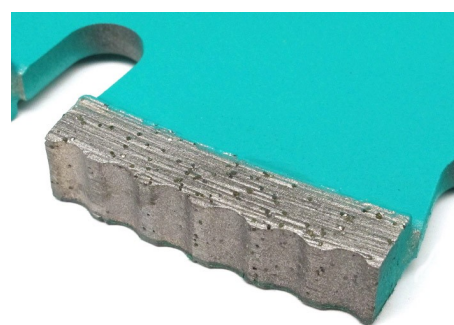

Ø	Hul	Varenr.	Antal Seg.	Segmentmål (l x h x b)	Kode	Pris Dkr
300	25,4	204601	18	40 x 6 x 6	BBR0001	kr. 5.903,76
300	25,4	204603	18	40 x 6 x 8	BBR0003	kr. 6.258,72
300	25,4	204604	18	40 x 6 x 10	BBR0004	kr. 6.589,20
300	25,4	204605	18	40 x 6 x 12	BBR0005	kr. 6.923,76
300	25,4	204606	18	40 x 6 x 15	BBR0006	kr. 7.429,68
350	25,4	204607	21	40 x 6 x 6	BBR0007	kr. 6.678,96
350	25,4	204609	21	40 x 6 x 8	BBR0009	kr. 7.095,12
350	25,4	204610	21	40 x 6 x 10	BBR0010	kr. 7.482,72
350	25,4	204611	21	40 x 6 x 12	BBR0011	kr. 7.866,24
350	25,4	204612	21	40 x 6 x 15	BBR0012	kr. 8.457,84
400	25,4	204613	24	40 x 6 x 6	BBR0013	kr. 7.666,32
400	25,4	204615	24	40 x 6 x 8	BBR0015	kr. 8.135,52
400	25,4	204616	24	40 x 6 x 10	BBR0016	kr. 8.580,24
400	25,4	204617	24	40 x 6 x 12	BBR0017	kr. 9.020,88
400	25,4	204618	24	40 x 6 x 15	BBR0018	kr. 9.695,10
450	25,4	204619	26	40 x 6 x 6	BBR0019	kr. 8.506,80
450	25,4	204620	26	40 x 6 x 8	BBR0020	kr. 9.020,88
450	25,4	204621	26	40 x 6 x 10	BBR0021	kr. 9.494,16
450	25,4	204622	26	40 x 6 x 12	BBR0022	kr. 9.975,60
450	25,4	204623	26	40 x 6 x 15	BBR0023	kr. 10.705,92
500	25,4	204624	30	40 x 6 x 6	BBR0024	kr. 9.955,20
500	25,4	204625	30	40 x 6 x 8	BBR0025	kr. 10.542,72
500	25,4	204626	30	40 x 6 x 10	BBR0026	kr. 11.097,60
500	25,4	204627	30	40 x 6 x 12	BBR0027	kr. 11.644,32
500	25,4	204628	30	40 x 6 x 15	BBR0028	kr. 12.492,96

**[BIA - Abrasive Orange]** **"NY BETON"**

- Skæring grøn industri beton 6h—24h
- Abrasive beton (polypropylen fibre, abrasive aggregates, høj koncentration af jern)
- Vertical segmenter for beskyttelse af stambladet



Ø	Hul	Varenr.	Antal Seg.	Segmentmål (l x h x b)	N <sup>0</sup> Prot	Kode	Pris Dkr
300	25,4	204203	21	40 x 10 x 2,8	3	BIA1003	kr. 3.594,48
350	25,4	204204	24	40 x 10 x 2,8	3	BIA1004	kr. 4.014,72
400	25,4	204205	28	40 x 10 x 2,8	4	BIA1005	kr. 4.957,20

**[BIB - Compact Grey]** **"NY BETON"**

- Skæring grøn industri beton 6h—24h
- Universal, compact to semi-Abrasive beton (hard aggregates, polypropylen fibre, høj koncentration af jern)
- Vertical segmenter for beskyttelse af stambladet



Ø	Hul	Varenr.	Antal Seg.	Segmentmål (l x h x b)	N <sup>0</sup> Prot	Kode	Pris Dkr
300	25,4	204301	20	40 x 9 x 2,8	3	BIB1001	kr. 2.884,56
350	25,4	204302	24	40 x 9 x 2,8	3	BIB1002	kr. 3.451,68
400	25,4	204303	28	40 x 9 x 2,8	4	BIB1003	kr. 5.010,24
450	25,4	204304	32	40 x 9 x 3,6	4	BIB1004	kr. 6.152,64

**[BIC - Compact Emerald]** **"NY BETON"**

- Skæring grøn industri beton 6h—24h
- Kompakt beton (hard aggregates, polypropylen fibre, høj koncentration af jern)
- Vertical segmenter for beskyttelse af stambladet



Ø	Hul	Varenr.	Antal Seg.	Segmentmål (l x h x b)	N <sup>0</sup> Prot	Kode	Pris Dkr
300	25,4	204501	21	40 x 10 x 2,4	3	BIC1001	kr. 2.872,32
300	25,4	204502	21	40 x 10 x 2,8	3	BIC1002	kr. 3.047,76
350	25,4	204503	24	40 x 10 x 2,8	3	BIC1003	kr. 3.447,60

**[GOLD Klinger]** 

- Armeret beton
- Beton m/ flint
- Gammelt beton
- Europæisk fremstillet

Valg af klinger bestemmes sædvanligvis af maskintype, KW, betontype, armering, flint, RPM etc.

Diaflex lagerfører klinger ud fra markedets efterspørgsel. Typisk vælges klingerne for mindre maskiner i Gold15, for kraftige maskiner, hvor der ønskes længere levetid, vælges typisk Gold17 eller Gold20.

Goldklingerne er kun et udpluk ad Diaflex' program af klinger.

Kontakt endelig én af vores sælgere for yderligere valgmuligheder.

Ø	GOLD 15 <15kW	GOLD 17 15 til 20kW	GOLD 20 20 til 30kW
600	3,8		
600	4,4		
600	4,7		
600	5,0		
700	4,0		
700	4,4		
700	4,7		
700	5,0		
800	4,4		
800	4,7		
800	5,0		
900	4,4		
900	4,7		
900	5,0		
1000	4,4		
1000	4,7		
1000	5,0		
1200	4,4		
1200	4,7		
1200	5,0		
1400	4,4		
1400	4,7		
1400	5,0		
1500	4,4		
1500	4,7		
1500	5,0		
1600	4,4		
1600	4,7		
1600	5,0		

Ring for pris

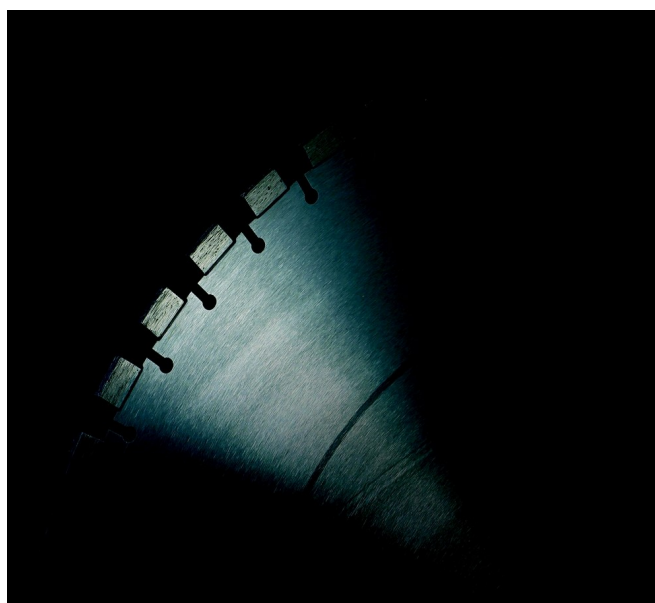
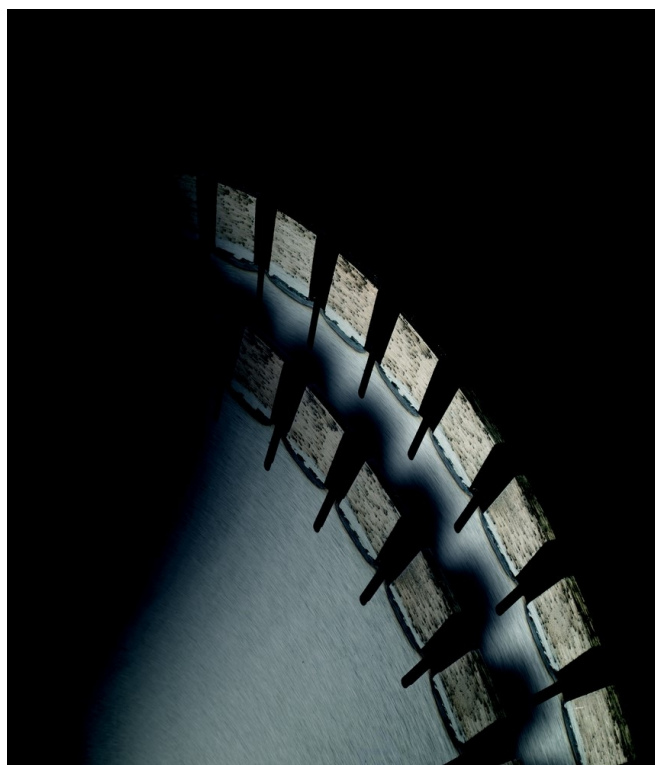

**[CPH Klinger]**

- Armeret beton
- Beton m/ flint
- Gammelt beton
- Europæisk fremstillet

Ø	
600	3,8
600	4,4
600	4,7
600	5,0
700	4,0
700	4,4
700	4,7
700	5,0
800	4,4
800	4,7
800	5,0
900	4,4
900	4,7
900	5,0
1000	4,4
1000	4,7
1000	5,0
1200	4,4
1200	4,7
1200	5,0
1400	4,4
1400	4,7
1400	5,0
1500	4,4
1500	4,7
1500	5,0
1600	4,4
1600	4,7
1600	5,0

Ring for pris

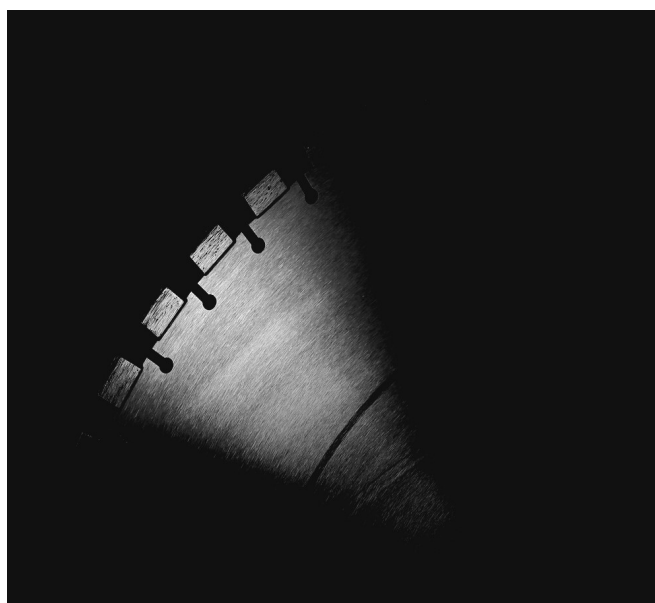

## Diaflex Betonsliber

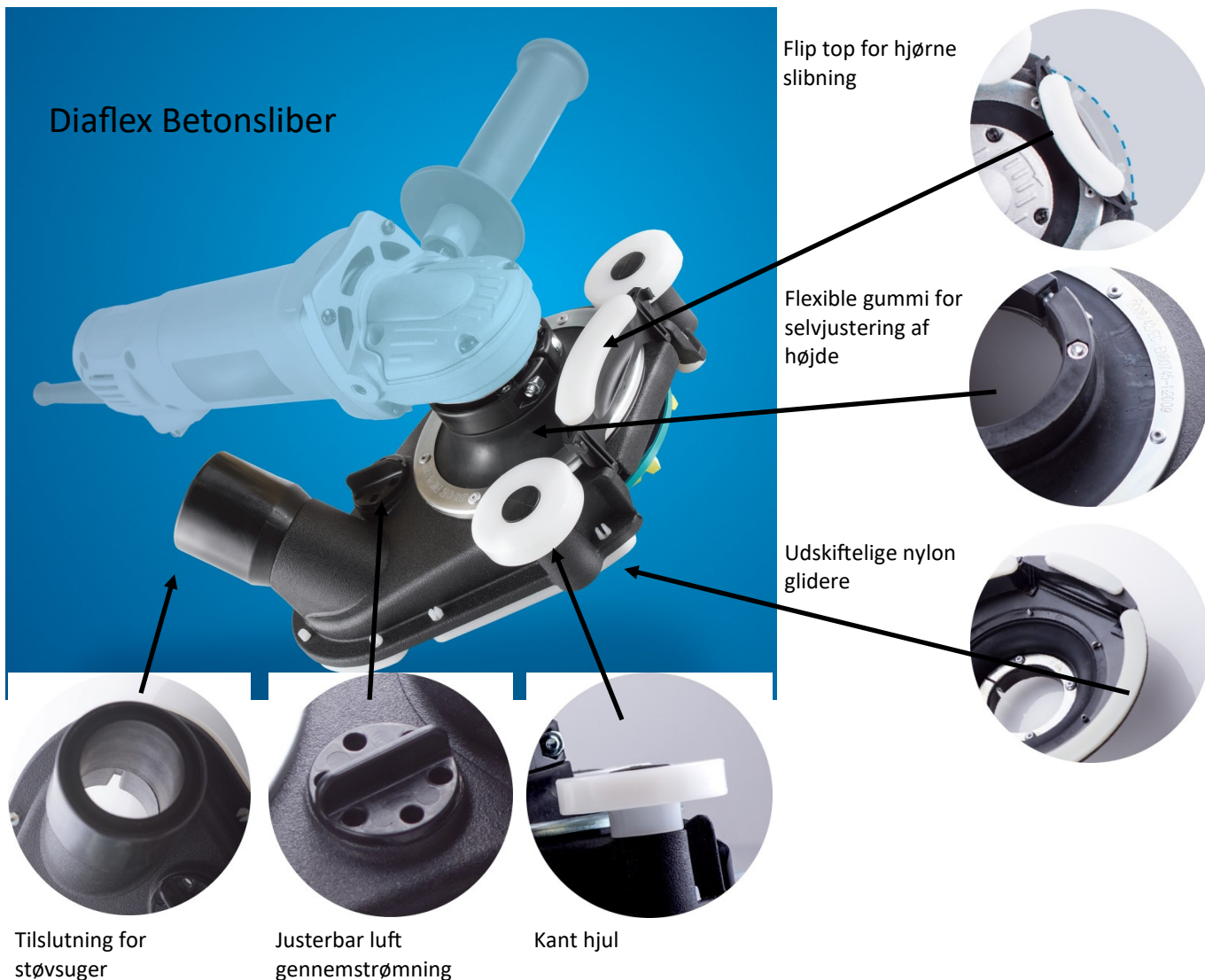

## [RAS - SUPER RAPTOR]



- Skrabning og overfladebehandling af beton.
- Velegnet til fliselim og epoxy.
- Stor kontaktflade til arbejde i blødt beton
- Lang levetid



Patented

Ø	Hul	Varenr.	Antal Seg.	Segmentmål (l x h x b)	Kode	Pris Dkr
125	22,2	201425	8	17 x 5 x 8,0	RAS125.01	kr. 2.044,08
150	19,0	201427	10	17 x 5 x 8,0	RAS150.01	kr. 2.574,48
180	22,2	201428	12	17 x 5 x 8,0	RAS180.01	kr. 3.219,12

**[RAP - RAPTOR]** 

- Skrabning og overfladebehandling af beton.
- Velegnet til fliselim og epoxy.
- Stor kontaktflade til arbejde i blødt beton
- Ekstra lang levetid

**Patented**

Ø	Hul	Varenr.	Antal Seg.	Segmentmål (l x h x b)	Kode	Pris Dkr
125	22,2	201420	8	17 x 5 x 5,5	RAP125.01	kr. 1.770,72
150	19,0	201422	10	17 x 5 x 5,5	RAP150.01	kr. 2.162,40
180	22,2	201421	12	17 x 5 x 5,5	RAP180.01	kr. 2.949,84



- Fjerner selv de hårdeste adhesive belægninger.
- Raptor er specielt udviklet til fjernelse af epoxy samt gummibelægninger, men kan også bruges til mange andre materialer.
- Med Raptoren er det muligt at holde en meget høj arbejdshastighed, samt at holde prisen pr. sleben kvadratmeter nede.
- De patenterede tænder på Raptoren gør at diamantsegmenterne kommer ind under belægningen og rykker derfor store stykker af materialet af.

**[SKR - SCRAPER PCD]** 

- Fjernelse af klæbende belægninger på betonoverflader (Epoxy coatings, spartelmasse, tjære, gips, limrester)
- Fjernelse af asbest

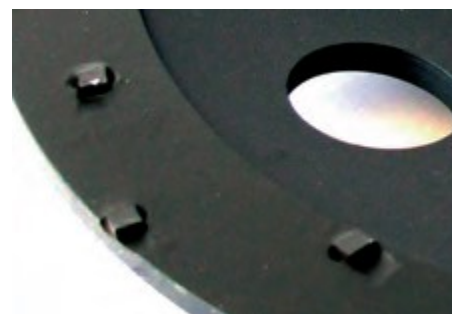

Ø	Varenr.	Antal Seg.	Kode	Pris Dkr
125	201438	12	SKR125.01	kr. 1.020,00
175	201439	24	SKR175.01	kr. 1.872,72

**[BOC - BOOMY GUL]** 

- TurboStart (Selvskærpnde segmenter)
- Beton, cement (Grov slibning)
- Højt output

**Patented**

Ø	Hul	Varenr.	Antal Seg.	Segmentmål (l x h x b)	Kode	Pris Dkr
100	M14*	201402	5	40 x 5 x 8,0	BO100C.05	kr. 1.370,88
100	22,2	201403	5	40 x 5 x 8,0	BO100C.04	kr. 1.370,88
125	22,2	201404	8	40 x 5 x 8,0	BO125C.02	kr. 1.603,44
150	19,0	201400	10	40 x 5 x 8,0	BO150C.02	kr. 2.072,64
180	22,2	201405	10	40 x 5 x 8,0	BO180C.03	kr. 2.288,88

\*M14 gevindet passer på de fleste vinkelslibere.

**[BOG - BOOMY GRØN]** 

- TurboStart (Selvskærpnde segmenter)
- Granit, beton, terazzo, kalksten, cement (Fin slibning)
- Højt output, lang levetid

**Patented**

Ø	Hul	Varenr.	Antal Seg.	Segmentmål (l x h x b)	Kode	Pris Dkr
100	M14*	201414	5	40 x 5 x 8,0	BO100G.05	kr. 1.468,80
100	22,2	201413	5	40 x 5 x 8,0	BO100G.04	kr. 1.468,80
125	22,2	201416	8	40 x 5 x 8,0	BO125G.02	kr. 1.770,72
150	19,0	201401	10	40 x 5 x 8,0	BO150G.02	kr. 2.280,72
180	22,2	201417	10	40 x 5 x 8,0	BO180G.03	kr. 2.525,52

M14 gevindet passer på de fleste vinkelslibere.

**[BOF - BOOMY GRÅ]**

- Granit, marmor
- Finish

Ø	Hul	Varenr.	Antal Seg.	Segmentmål (l x h x b)	Kode	Pris Dkr
125	22,2	201410	7	50 x 16 x 5,5	BO125F.01	kr. 1.795,20
150	19,0	201411	8	50 x 16 x 5,5	BO150F.01	kr. 2.305,20
180	22,2	201412				kr. 2.550,00

M14 gevindet passer på de fleste vinkelslibere.





**[BUTTERFLY]**

- TurboStart (Selvskærpende segmenter)
- Beton, cement (Grov slibning)
- Højt output

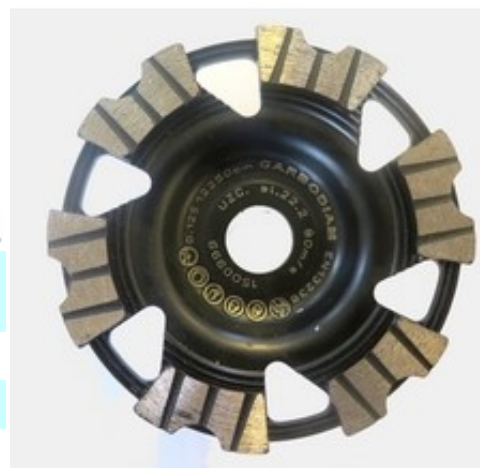

Ø	Hul	Varenr.	Antal Seg.	Segmentmål (l x h x b)	Kode	Pris Dkr
125	22,2	201460				kr. 1.251,54
130	22,2	201461				kr. 1.321,92
150	19,0	201462				kr. 1.495,32
180	22,2	201463				kr. 1.773,78



# MITO551 Professional Floor Grinding Machine with Planetary Head

**Mito 551:** med 550 mm arbejdsområde for små til mellemstore flader.

**Hovedtræk:**

- Arbejdsbredde 550 mm, 3 stk. 200 mm værktøj.
- Hastighed af værktøjer spænder fra 400 til 1300 rpm.
- Stærk gearkasse med termo-hærdet stålgear for et længere liv.
- Ingen støj under arbejdet.
- Autoudjævnende planetarisk system.
- Kraftig HP motor 4 eller 5,5
- 46L. Vandbeholder



Counter Rotating System



Optional

Removable Planetary Head for easy transport

**DCS SYSTEM**

**ESTIMATED PRODUCTION RATES**

SUPERCONCRETE 7 step	8-12 m <sup>2</sup> / h
Concrete Grinding 1 step	35-70 m <sup>2</sup> / h
Terrazzo Polishing 5 step	8-12 m <sup>2</sup> / h
Resin Removing 1 step	35-70 m <sup>2</sup> / h
Varnish Removing 1 step	35-70 m <sup>2</sup> / h
Marble Polishing 5 step	6-10 m <sup>2</sup> / h
Granite Polishing 7 step	5-6 m <sup>2</sup> / h

**TECHNICAL DATA**

Model	Motor	Drive Inverter	Volt	Hertz	Amp	Speed tools rpm	Dimensions WxHxD cm	Weight	Pris Dkr
Mito 551	2900 Watt max	—	220	50	—	800	120x125x57	135 kg	Ring for pris
Mito 551 VS	3000 Watt max	4kw mono	220	50/60	—	400-1000	120x125x57	140 kg	Ring for pris
Mito 551 TS	5,5 HP	—	380-480	50/60	16	800	120x125x57	150 kg	Ring for pris
Mito 551 TS VS	5,5 HP	4kw 3ph	380-480	50/60	16	600-1000	120x125x57	160 kg	Ring for pris



Ergonomic control Panel for easy use

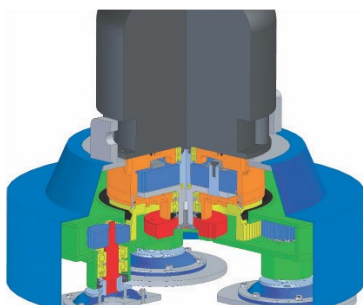

Tempered steel gear box for long lasting



Planetary system with big working width 550mm

# MITO451

 Floor Grinding Machine with “DCS System” and variable speed

Mito serien introducerer det innovative DCS-system, der giver i én enkelt maskine funktionerne af to. • Funktionen Hercules bruger modsat roterende satellitter slibning og polering af beton, marmor og natursten gulve. • Det kraftfulde DCS-system øger satellitternes rotationshastighed, Mito står for højtydende industrielle maskiner til gulvforberedelse. Velegnet til hurtig fjernelse af harpiks og lim, til hurtig afmontering af aggregaterne og til hurtig udjævning af meget ujævne overflader.

- Hovedtræk:**
- Arbejdsbredde 450 mm, 3 stk 200 mm værktøj.
  - Hastighed af værktøjer spænder fra 400 til 1000 rpm.
  - Stærk gearkasse med termo-hærdet stålgear for et længere liv.
  - Ingen støj under arbejdet. • Autoudjævrende planetarisk system.
  - Umiskendelig italiensk design.



DCS SYSTEM



ESTIMATED PRODUCTION RATES

Task	Estimated Production Rate
SUPERCONCRETE 7 step	7-10 m <sup>2</sup> / h
Concrete Grinding 1 step	30-35 m <sup>2</sup> / h
Terrazzo Polishing 5 step	6-9 m <sup>2</sup> / h
Resin Removing 1 step	30-60 m <sup>2</sup> / h
Varnish Removing 1 step	30-60 m <sup>2</sup> / h
Marble Polishing 5 step	5-8 m <sup>2</sup> / h
Granite Polishing 7 step	4-6 m <sup>2</sup> / h



Counter Rotating System



Optional

## TECHNICAL DATA

Model	Motor	Drive Inverter	Volt	Hertz	Amp	Speed tools rpm	Dimensions WxHxD cm	Weight	Pris Dkr
Mito 451	2900	—	220	50	—	800	120x125x47	130 kg	Ring for pris
Mito 451 VS	3000	4kw	220	50/60	—	800-1000	120x125x47	135 kg	Ring for pris

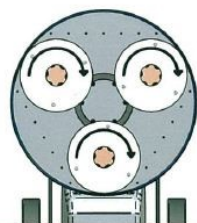

Satellites Rotation only

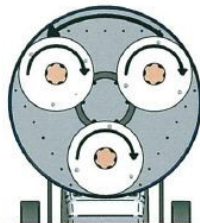

Counter-Rotating System



Full Metal Gear Box

# MITO450

Floor Grinding Machine with "DCS System" and variable speed



DCS SYSTEM

Op til 50kg.  
ekstra vægt



Op til 50kg.  
ekstra vægt

Op til 50kg.  
ekstra vægt

Op til 50kg.  
ekstra vægt

Op til 50kg.  
ekstra vægt

## ESTIMATED PRODUCTION RATES

Task	Estimated Production Rate
SUPERCONCRETE 7 step	7-10 m <sup>2</sup> / h
Concrete Grinding 1 step	30-35 m <sup>2</sup> / h
Terrazzo Polishing 5 step	6-9 m <sup>2</sup> / h
Resin Removing 1 step	30-60 m <sup>2</sup> / h
Varnish Removing 1 step	30-60 m <sup>2</sup> / h
Marble Polishing 5 step	5-8 m <sup>2</sup> / h
Granite Polishing 7 step	4-6 m <sup>2</sup> / h

## TECHNICAL DATA

Model	Motor	Drive Inverter	Volt	Hertz	Amp	Speed tools rpm	Dimensions WxHxD cm	Weight	Pris Dkr
Mito 450	2900	—	220	50	—	800	120x125x47	135 kg	Ring for pris
Mito 450 VS	3000	4kw	220	50/60	—	800-1000	120x125x47	135 kg	Ring for pris

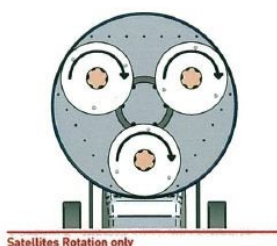

Satellites Rotation only

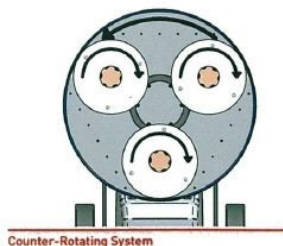

Counter-Rotating System



Full Metal Gear Box

## DIAMANTVÆRKTØJ TIL MITO

**DD series** Diamantværktøj til hårdt beton.

401527	DD00 Grit 20 - 4 segmenter	Ø200	kr. 1.001,64
401521	DD0 Grit 40 - 4 segmenter	Ø200	kr. 909,84
401550	DD1 Grit 70 - 4 segmenter	Ø200	kr. 1.052,64
401551	DD2 Grit 140 - 4 segmenter	Ø200	kr. 1.052,64



**DA series** Diamantværktøj til medium-hårdt beton.  
(Brug ikke på abrasive beton).

401575	DA00 Grit 20 - 6 segmenter	Ø200	kr. 1.363,74
401576	DA0 Grit 40 - 6 segmenter	Ø200	kr. 1.059,78
401577	DA1 Grit 70 - 6 segmenter	Ø200	kr. 1.059,78
401578	DA2 Grit 140 - 6 segmenter	Ø200	kr. 1.059,78
401546	DA00 Grit 20 - 6 segmenter	Ø240	kr. 1.389,24
401547	DA0 Grit 40 - 6 segmenter	Ø240	kr. 1.136,28
401548	DA1 Grit 70 - 6 segmenter	Ø240	kr. 1.136,28
401549	DA2 Grit 140 - 6 segmenter	Ø240	kr. 1.136,28

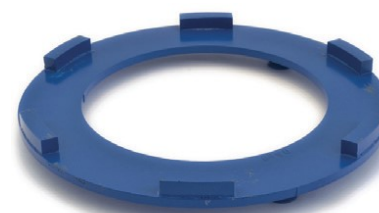

**CA series** Diamantværktøj til abrasive beton

401573	CA00 Grit 20 - 6 segmenter	Ø200	kr. 1.642,20
401522	CA0 Grit 40 - 6 segmenter	Ø200	kr. 1.558,56
401555	CA1 Grit 70 - 6 segmenter	Ø200	kr. 1.472,88
401572	CA2 Grit 140 - 6 segmenter	Ø200	kr. 1.356,60
401540	CA00 Grit 20 - 6 segmenter	Ø240	kr. 1.768,68
401541	CA0 Grit 40 - 6 segmenter	Ø240	kr. 1.615,68
401542	CA1 Grit 70 - 6 segmenter	Ø240	kr. 1.507,56
401543	CA2 Grit 140 - 6 segmenter	Ø240	kr. 1.364,76



## Beton Hardener - Beton Guard Lithium

401554	Beton Hardener Lithium	5L	kr. 1.052,64
401555	Beton Hardener Lithium	25L	kr. 4.418,64
401515	Beton Guard Lithium	5L	kr. 2.356,20
401524	Beton Guard Lithium	25L	kr. 10.730,40



# TERMINATOR240



Samich har designet et komplet udvalg af betonslibere og diamantprodukter, som giver mulighed for at håndtere alle gulve og specifikt formål.

**Terminator 240** er en enkelt-disc betonsliber specielt designet til små og mellemstore vandret overfladeforberedelse, det gør det muligt at slibe ca. 200-250 sq. ft. per time.

Terminator 240 er meget let og behagelig at bruge pga. dens lave vibrationer. Terminatoren 240 enkelt disk slibemaskine er støvfri når den er tilsluttet til det relevante DUSTNATOR støvindsamlingsystem. Perfekt maskine til overfladebehandling af små til mellemstore gulve, overfladeudjævning, betonforberedelse før coating, fjernelse af coating defekter eller klister, fjernelse tætningsmaterialer, thin-sets, malingsophobninger, harpiks og mere, reparere beskadigede betonplader, udjævning af ru overflader, regn mærker eller murske mærker.

**Hovedtræk:** • Massiv stålkrop • Kraftfuld motor med høj effekt

- Støvfri, når den er tilsluttet en passende Dustnator støvsamler
- Vakuumport og vandtank til rådighed
- Kan slibe helt op til kanten takket være dets specielle design
- Single-head slibemaskine Ø 240 mm med hurtig samlingssystem
- Justerbar slibe dybde • Brugervenlig og behagelig at bruge pga. lave vibrationer
- Kompakt og let: let at transportere og bære ovenpå.



## ESTIMATED PRODUCTION RATES

Concrete Grid 1 step	20-25 m <sup>2</sup> / h
Terrazzo Grid 1 step	45-75 m <sup>2</sup> / h
Resin Removing 1 step	15-25 m <sup>2</sup> / h
Varnish Removing 1 step	15-30 m <sup>2</sup> / h

## TECHNICAL DATA

Model	Motor	Volt	Hertz	Amp	Speed tools rpm	Dimensions WxHxD cm	Weight	Pris Dkr
Terminator 240	2900	230	50	—	1400	70x110x25	53 kg	Ring for pris
Terminator 240 VS	3000	230	50/60	—	800-2000	70x110x25	53 kg	Ring for pris

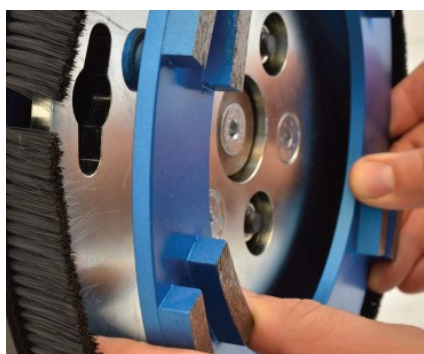

Floating Disc 240mm



Lateral inlet  
Ideel til at arbejde på det samme niveau indtil væggen

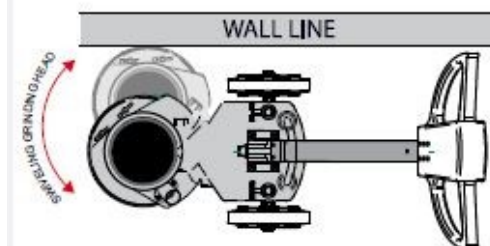

Swiveling grinding head  
Mulighed for at arbejde helt ind til væggen

## DIAMANTVÆRKTØJ TIL TERMINATOR 240

**TCK series** Diamantværktøj med TCK teknologi til betongulve.

401621	TCK00S Grit 12 - 12 segmenter	Ø240	3292
401622	TCK00 Grit 20 - 12 segmenter	Ø240	2930
401623	TCK0 Grit 40 - 12 segmenter	Ø240	2146



**DA series** Diamantværktøj til medium-hårdt beton.  
(Brug ikke på abrasive beton).

401625	DA00 Grit 20 - 12 segmenter	Ø240	kr. 2.399,04
401626	DA0 Grit 40 - 12 segmenter	Ø240	kr. 1.666,68
401627	DA1 Grit 70 - 12 segmenter	Ø240	kr. 1.666,68
401628	DA2 Grit 140 - 12 segmenter	Ø240	kr. 1.666,68

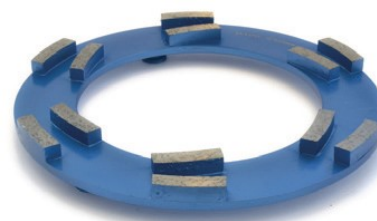

## VERTICAL LEGEND

# LEGEND Super Hand Grinder



**Legend Super Hand Grinder** er den ideelle maskine til at opnå en perfekt polering af køkkenbordet, hylder, borde og andre smalle områder.

Den kan bruges som en Beton- eller marmorkant slibemaskine, samt en trappe buskhammer og som en samlings 'Chaser' takket være dens ekstra tilbehør.

#### Hovedtræk:

- Det er eneste håndsliber med IP54 beskyttelse i verden.
- Enestående asynkron motorstyrke, i forhold til en traditionelle motorer holder den længere takket være at den er beskyttet mod ydre påvirkninger som vand eller støv.
- Store gear og lejer i forhold til traditionelle håndslibere.
- Mulighed for at understøtte den med en bagvedliggende kugleformede hjul vogn for at opnå en perfekt flad overflade (for at undgå bølgeeffekten).
  - Front LED lys for at oplyse arbejdsområdet.
  - Roterende-hoved-funktion.
  - Hastighedskontakt for slibning / polering.
  - Udførelse af våd eller tør slibning (udstyret med en vand dyse).



Legend Super Hand Grinder Top omfatter: Kugleformede baghjul med uafhængig tilpasning, beskyttende sugehætte 125mm, stænkskærm 125mm, blød platorello 125mm, justerbart hoved med kugleformet guide.

Legend Super Hand Grinder Top VS omfatter: Kugleformede baghjul med uafhængig tilpasning beskyttende sugehætte 125mm, stænkskærm 125mm, blød platorello 125mm, justerbart hoved med kugleformet guide, variabel hastighed.

LED-lys og andet tilbehør er valgfri.



Håndsliber med justerbart hoved, for hjørner, kanter, bordplader, fodpaneler, trapper, for bush-hammer trapper og små flader og åbne samlinger.

#### TECHNICAL DATA

Model	Motor	Tools	Tools	Dimensions WxHxD cm	Weight	Pris Dkr
Legend Super Hand Grinder	750W	125/150mm	125/150mm	45x33x23	10 kg	Ring for pris
219003 Legend Super Hand Grinder VS	750W	125/150mm	125/150mm	45x33x23	10 kg	Ring for pris



For professional grinding



Grinding and polishing perimeters and edges.



Wet and Dry grinding operation.



## VÆRKTØJ TIL LEGEND Super Hand Grinder

### Jaguar Flex Ø125mm

401531	Jaguar flex grit 30 - Grøn	Ø125	kr. 275,40
401532	Jaguar flex grit 60 - M. Grøn	Ø125	kr. 275,40
401533	Jaguar flex grit 120 - Sort	Ø125	kr. 275,40
401534	Jaguar flex grit 220 - Rød	Ø125	kr. 275,40
401535	Jaguar flex grit 400 - Gul	Ø125	kr. 275,40
401536	Jaguar flex grit 800 - Hvid	Ø125	kr. 275,40
401537	Jaguar flex grit 1500 - Blå	Ø125	kr. 275,40
401538	Jaguar flex grit 3500 - Grå	Ø125	kr. 275,40



### Tools Holder Kit

Sættet indeholder Vakuum Skærm, Velcro tool holder og stink-skærm

SR45047	Tool holder Kit	Ø125	kr. 926,16
SR45049	Tool holder Kit	Ø150	kr. 969,00



# LEGEND COUNTER TOP



**Legend Counter Top** er en INNOVATION AWARD WINNING maskine, der er perfekt afbalanceret og nem at bruge på trapper, bordplader og svært tilgængelige steder. Det har et modsat roterende planetarisk system, der gør det muligt for dig at slibe, skærpe og polere alle overflader. Den er konstrueret og bygget med høj præcision hvilket gør den stabil og praktisk anvendelig. Legend C.T. har meget tilbehør, som tillader dig at omdanne den til en mindre gulvslibemaskine til små opgaver. Den kan også anvendes til overfladebehandling af træ

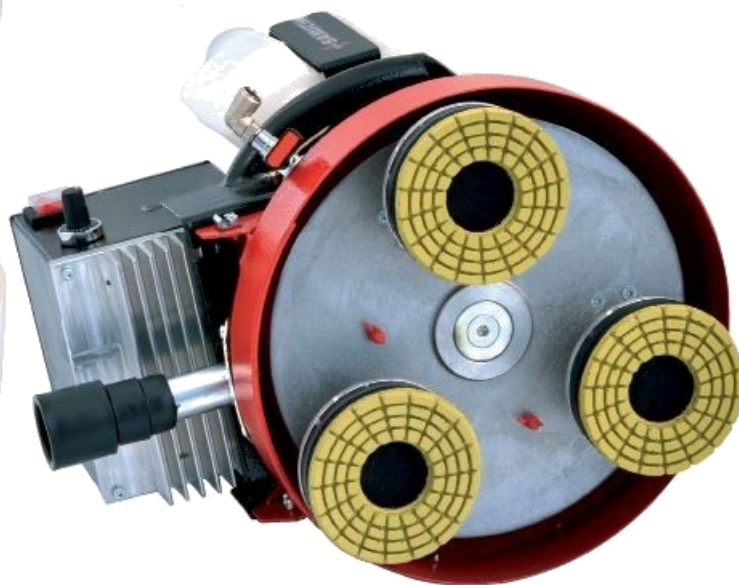

Counter Rotating System

## TECHNICAL DATA

	Model	Motor	Tool Size	Working Widht	Speed Tools rpm	Dimensions WxHxD cm	Weight	Pris Dkr
219007	Counter Top 290	750W	3x100mm	290mm	1000	37x39x30	23 kg	kr. 20.407,14
219009	Counter Top 330	750W	3x140mm	330mm	1000	37x39x34	24 kg	kr. 20.407,14
219008	Counter Top 290 VS	750W	3x100mm	290mm	400-1500	37x39x30	26 kg	kr. 27.350,28
219010	Counter Top 330 VS	750W	3x140mm	330mm	400-1500	37x39x34	27 kg	kr. 27.350,28

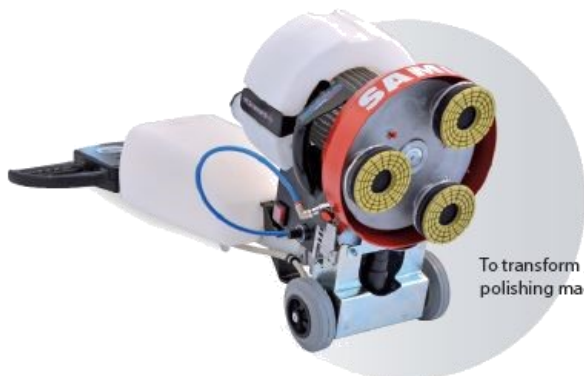

To transform it in a polishing machine



Long Handle optional

## VÆRKTØJ TIL LEGEND COUNTER TOP

### EASY KIT COUNTER TOP

Komplet Kit betående af Legend Counter Top, Vandtank 2L, Pad holder, komplet sæt Jaguar Flex fra G30 til G3500 og Trolley



Model		Pris Dkr
219507	Kit Counter Top 290	kr. 26.919,84
219509	Kit Counter Top 330	kr. 30.285,84
219508	Kit Counter Top 290 VS	kr. 32.810,34
219510	Kit Counter Top 330 VS	kr. 36.605,76

### Jaguar Flex Ø100mm



401640	Jaguar flex grit 30 - Grøn	Ø100	kr. 248,88
401641	Jaguar flex grit 60 - M. Grøn	Ø100	kr. 248,88
401642	Jaguar flex grit 120 - Sort	Ø100	kr. 248,88
401643	Jaguar flex grit 220 - Rød	Ø100	kr. 248,88
401644	Jaguar flex grit 400 - Gul	Ø100	kr. 248,88
401645	Jaguar flex grit 800 - Hvid	Ø100	kr. 248,88
401646	Jaguar flex grit 1500 - Blå	Ø100	kr. 248,88
401647	Jaguar flex grit 3500 - Grå	Ø100	kr. 248,88

### Jaguar Flex Ø140mm

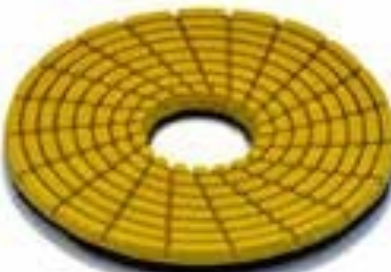

401650	Jaguar flex grit 30 - Grøn	Ø140	kr. 399,84
401651	Jaguar flex grit 60 - M. Grøn	Ø140	kr. 399,84
401652	Jaguar flex grit 120 - Sort	Ø140	kr. 399,84
401653	Jaguar flex grit 220 - Rød	Ø140	kr. 399,84
401654	Jaguar flex grit 400 - Gul	Ø140	kr. 399,84
401655	Jaguar flex grit 800 - Hvid	Ø140	kr. 399,84
401656	Jaguar flex grit 1500 - Blå	Ø140	kr. 399,84
401657	Jaguar flex grit 3500 - Grå	Ø140	kr. 399,84

### Velcro pad holder

401660	Velcro pad holder CounterTop 330	Ø140	kr. 212,16
401661	Velcro pad holder CounterTop 290	Ø100	kr. 134,64



### Counter Top Handles m/ vand tank

219512	Short Handle m/ tank 8L	CT 290/330	kr. 4.781,76
401661	Long Handle m/ tank 12L	CT 290/330	kr. 4.781,76

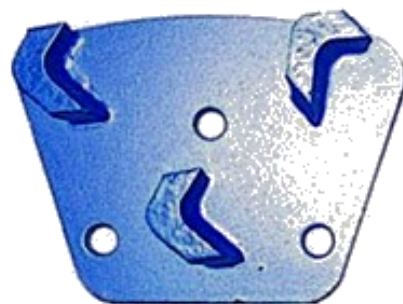
**[RAPTOR PADS]** 

- Fjerner klæbende belægninger fra betongulve.
- Epoxy, latex, lim, tjære.
- Fjernelse af asbest
- Skraber og sliber i én bevægelse

Passer på KFG550 og KFG750

Hul	Varenr.	Antal Seg.	Segmentmål (l x h x b)	Kode	Pris Dkr
M6	220302	2	17 x 5,0 x 5,5	PRAM604	588
M6	220312	2	17 x 7,5 x 6,0	PRAM607	612
M6	220303	3	17 x 5,0 x 5,5	PRAM605	688
M6	220313	3	17 x 7,5 x 6,0	PRAM608	740
M6	220304	4	17 x 5,0 x 5,5	PRAM606	772
M6	220314	4	17 x 7,5 x 6,0	PRAM609	844

**[QFD PADS]** 

- Grov slibning af beton
- Fjernelse af ekstra tykkelse

Passer på KFG550 og KFG750

Hul	Varenr.	Antal Seg.	Segment-højde	Kode	Pris Dkr
M6	220342	2	20	QFD87M602	kr. 856,80
M6	220343	3	20	QFD87M603	kr. 1.109,76



Passer på de fleste maskiner med pads for undersænkning.

Hul	Varenr.	Antal Seg.	Segment-højde	Kode	Pris Dkr
Undersænket	224142	2	20	QFD87FR02	kr. 856,80
Undersænket	224143	3	20	QFD87FR03	kr. 1.089,36

[PAC PADS] 

- Grov til fin slibning af betongulve
- **SURF2:** Fjernelse af ekstra tykkelse, fjernelse af belægningsrester, planering af overflader, forberedelse af grove gulve til polering, forberedelse af ny coating.
- **SURF3:** Finslibning, fjerner næsten alle ridser.
- **SURF4:** Forberedelse til polering, giver et "satin-look" uden ridser.
- **SURF5:** Forberedelse til polering, giver et "gloss-agtigt look", sidste trin inden polering med resin-skiverne.

Passer på KFG550 og KFG750



Hul	Varenr.	Type	Antal Seg.	Segmentmål (l x h x b)	Kode	Pris Dkr
M6	226001	SURF1	1	50 x 10,5x12,5	PIC18M601	kr. 1.020,00
M6	220031	SURF2	1	48 x 10 x 12	PAC25M604	kr. 607,92
M6	220032	SURF2	2	48 x 10 x 12	PAC25M605	kr. 1.020,00
M6	220041	SURF3	1	48 x 10 x 12	PAC60M607	kr. 599,76
M6	220042	SURF3	2	48 x 10 x 12	PAC60M608	kr. 1.020,00
M6	220051	SURF4	1	40 x 10 x 10	PC150M601	kr. 918,00
M6	220052	SURF4	2	40 x 10 x 10	PC150M602	kr. 869,04
M6	220061	SURF5	1	40 x 10 x 10	PC300M601	kr. 889,44
M6	220062	SURF5	2	40 x 10 x 10	PAC150M604	kr. 995,52

Passer på de fleste maskiner med pads for undersækning.

Hul	Varenr.	Type	Antal Seg.	Segmentmål (l x h x b)	Kode	Pris Dkr
Undersænket	224001	SURF2	1	48 x 10 x 12	PAC25FR04	kr. 607,92
Undersænket	224011	SURF2	2	48 x 10 x 12	PAC25FR05	kr. 1.020,00
Undersænket	224002	SURF3	1	48 x 10 x 12	PAC60FR07	kr. 599,76
Undersænket	224012	SURF3	2	48 x 10 x 12	PAC60FR08	kr. 1.020,00
Undersænket	224003	SURF4	1	40 x 10 x 10	PC150FR01	kr. 918,00
Undersænket	224013	SURF4	2	40 x 10 x 10	PC150FR02	kr. 869,04
Undersænket	224004	SURF5	1	40 x 10 x 10	PC300FR01	kr. 889,44
Undersænket	224014	SURF5	2	40 x 10 x 10	PC300FR02	kr. 995,52

Priserne er stykpriser. Der skal 9 pads til et sæt. (3 plader med 3 pads)

**[RAPTOR PLATE]** 

- Fjerner klæbende belægninger fra betongulve.
- Epoxy, latex, lim, tjære.
- Fjernelse af asbest
- Skraber og sliber i én bevægelse
- Passer bl.a. på: Errut, Bewag, SMG, HTC, Blastrac, King, Diamatic
- Ø250mm plade med 19mm centerhul

Varenr.	Antal pads	Antal Seg.	Segmentmål (l x h x b)	Kode	Pris Dkr
224181	8	3	17 x 5,0 x 5,5	PRC250.01	kr. 7.253,22
224191	8	3	17 x 7,5 x 6,0	PRC250.04	kr. 7.690,80
224182	4 + 4	3 / 4	17 x 5,0 x 5,5	PRC250.02	kr. 7.650,00
224192	4 + 4	3 / 4	17 x 7,5 x 6,0	PRC250.05	kr. 8.162,04
224183	8	4	17 x 5,0 x 5,5	PRC250.03	kr. 8.048,82
224193	8	4	17 x 7,5 x 6,0	PRC250.06	kr. 8.633,28

Priserne er for en komplet plade med 8 pads.

**[RAPTOR PADS]** 

- Fjerner klæbende belægninger fra betongulve.
- Epoxy, latex, lim, tjære.
- Fjernelse af asbest
- Skraber og sliber i én bevægelse

Hul	Varenr.	Antal Seg.	Segmentmål (l x h x b)	Kode	Pris Dkr
Undersænket	224102	2	17 x 5,0 x 5,5	PRAFR04	kr. 599,76
Undersænket	224112	2	17 x 7,5 x 6,0	PRAFR07	kr. 624,24
Undersænket	224103	3	17 x 5,0 x 5,5	PRAFR05	kr. 701,76
Undersænket	224113	3	17 x 7,5 x 6,0	PRAFR08	kr. 754,80
Undersænket	224104	4	17 x 5,0 x 5,5	PRAFR06	kr. 787,44
Undersænket	224114	4	17 x 7,5 x 6,0	PRAFR09	kr. 860,88

Priserne er stykpriser.

**[P16 PADS]** 

- Overfladebehandling, fin slibning, planslibning af fliser
- Højt output, lang levetid.
- Passer bl.a. på: Errut, Bewag, SMG, HTC, Blastrac, King, Diamatic.
- Vælg mellem M6 eller undersænkede huller.

Hul	Varenr.	Antal Seg.	Segmentmål (l x h x b)	Kode	Pris Dkr
Undersænket	225001	1	48 x 8 x 12	P16FR01	kr. 558,96
M6	225011	1	48 x 8 x 12	P16M601	kr. 558,96
Undersænket	225002	2	48 x 8 x 12	P16FR02	kr. 889,44
M6	225012	2	48 x 8 x 12	P16M602	kr. 889,44

Priserne er stykpriser.

**[P20 PADS]** 

- Overfladebehandling, fin slibning, planslibning af fliser
- Højt output, lang levetid.
- Passer bl.a. på: Errut, Bewag, SMG, HTC, Blastrac, King, Diamatic.
- Vælg mellem M6 eller undersænkede huller.

Hul	Varenr.	Antal Seg.	Segmentmål (l x h x b)	Kode	Pris Dkr
Undersænket	225101	1	33 x 7 x 7,5	P20FR01	kr. 456,96
M6	225111	1	33 x 7 x 7,5	P20M601	kr. 456,96
Undersænket	225102	2	33 x 7 x 7,5	P20FR02	kr. 681,36
M6	225112	2	33 x 7 x 7,5	P20M602	kr. 681,36
Undersænket	225103	3	33 x 7 x 7,5	P20FR03	kr. 840,48
M6	225113	3	33 x 7 x 7,5	P20M603	kr. 840,48

Priserne er stykpriser.

**[NITTO 21]**

- UV-beständig plastiktape
- 15mm x 10mtr.



Farve	Varenr.	Antal pakke/karton	Pris pr. rll. Dkr
Sort	521001	10 / 200 stk.	kr. 4,79
Iso-grå	521013	10 / 200 stk.	kr. 4,79
Rød	521004	10 / 200 stk.	kr. 4,79
L.Blå	521012	10 / 200 stk.	kr. 4,79

**[NITTO 21]**

- UV-beständig plastiktape
- 50mm x 20mtr.

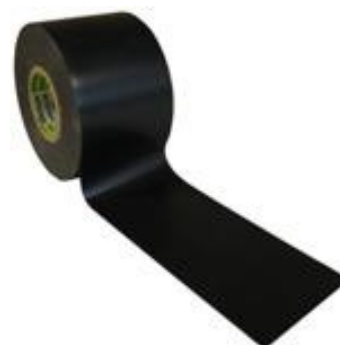

Farve	Varenr.	Antal karton	Pris pr. rll. Dkr
Sort	525001	48 stk.	kr. 31,62
Iso-grå	525013	48 stk.	kr. 30,60

**[NITTO 21]**

- UV-beständig plastiktape
- 100mm x 10mtr.



Farve	Varenr.	Antal karton	Pris pr. rll. Dkr
Sort	526001	40 stk.	kr. 30,60

**[NITTO 228SK]**

- UV-beständig plastiktape
- Flexibelt, også ved kuldegrader



Farve	Varenr.	Bredde (mm)	Længde (meter)	Antal karton	Pris pr. rll. Dkr
Sort	538201	19	20	120 stk.	kr. 15,30
Sort	538301	25	20	96 stk.	kr. 22,44
Sort	538401	38	20	60 stk.	kr. 30,60
Sort	538501	50	20	48 stk.	kr. 40,80





**[NITTO 12FB]**

- Vulkaniseringstape

Farve	Varenr.	Bredde (mm)	Længde (meter)	Antal karton	Pris pr. rll. Dkr
Sort	512038	38	1,5	10 stk.	kr. 59,16

**[NITTO 15]**

- Selvvulkaniserende tape

Farve	Varenr.	Bredde (mm)	Længde (meter)	Antal pakning	Pris pr. rll. Dkr
Sort	515195	19	5	10 stk.	kr. 26,52
Sort	515255	25	10	10 stk.	kr. 70,38
Sort	515385	38	10	5 stk.	kr. 106,08

**[NITTO 57Go]**

- En meget fleksibel tape af butylgummi for tætning, isolering og korrosionsbeskyttelse af uregelmæssige emner.
- Nedgravning af kabler, multianvendelse

Farve	Varenr.	Bredde (mm)	Længde (meter)	Antal karton	Pris pr. rll. Dkr
Sort	571502	150	2	1 stk.	kr. 388,62
Sort	571510	150	10	1 stk.	kr. 1.776,84

**[NITTO 51]**

- Ekstra kraftig tape, harpiksklæber
- Meget velegnet til beskyttelse ved sandblæsning

Farve	Varenr.	Bredde (mm)	Længde (meter)	Antal pakning	Pris pr. rll. Dkr
Sort	551301	25	10	160 stk.	kr. 31,62
Sort	551381	38	10	100 stk.	kr. 47,94
Sort	551501	50	10	80 stk.	kr. 63,24
Sort	551541	50	30,5	20 stk.	kr. 160,14



**[NITTO 7288]**

## • Maskingtape

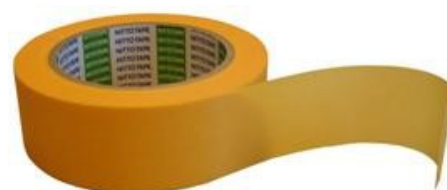

Farve	Varenr.	Bredde (mm)	Længde (meter)	Antal karton	Pris pr. rll. Dkr
Gul	588015	15	50	65 stk.	kr. 24,48
Gul	588019	19	50	50 stk.	kr. 29,58
Gul	588025	25	50	40 stk.	kr. 38,76
Gul	588038	38	50	25 stk.	kr. 57,12
Gul	588050	50	50	20 stk.	kr. 73,44

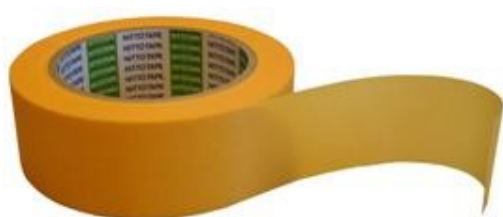

Nitto's no. 7288 er næste generations maskeringstape.

- Har en meget bedre holdbarhed end normale maskeringstaper.
- Efterlader ikke limrester efter brug, selv efter at have siddet i flere uger.
- Let at rive over med håndkraft.
- Høj klæbeevne under processen.
- Meget fin kant.
- Nemt at lave bløde kurver under påsættelse.
- Holder sin mekaniske styrke, så den knækker ikke ved aftagelse.
- Holder til høje temperaturer (150° i en time)
- Kan bruges både udendørs og indendørs.
- Kan også bruges under autolakering.

**[CPA100]**

- Flexibel, med varmesmeltet lim på indersiden.
- Indkapsling af bl.a. kabler, ledninger, splejsninger.
- Selvslukkende, temperatur område -55° C til 110° C
- Krympetemp.: Fra +120° C
- Gennemslagsspænding: 20KV/mm min
- Længder af 1,2mtr.

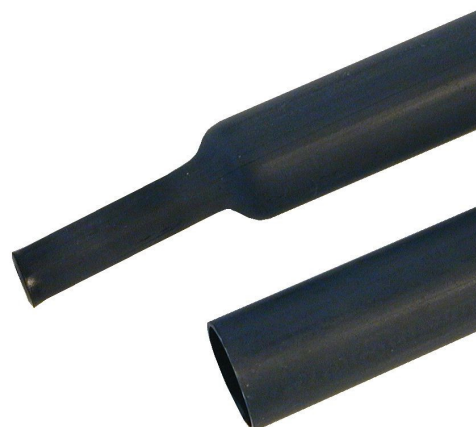

Ø	Krympefaktor	Varenr.	Pris Dkr
3,0	3:1	810030	kr. 41,82
4,0	4:1	810040	kr. 43,86
4,8	3:1	810048	kr. 46,92
6,0	3:1	810060	kr. 54,06
9,0	3:1	810090	kr. 76,50
12,0	3:1	810120	kr. 84,66
19,0	3:1	810190	kr. 121,38
24,0	3:1	810240	kr. 162,18
32,0	4:1	810320	kr. 192,78
40,0	3:1	810400	kr. 223,38
52,0	4:1	810520	kr. 362,10

**Diaflex lagerfører også:**

- Transperant krympeflex m/klæb
- Krympeflex i farver
- Krympeflex fra Ø1,2mm til Ø120mm
- Reparationsmuffer (lynlåsmuffer)
- Installatørsæt m.m.
- Krympetape 50mm - 300mm

**[CFM-SEALANT]**

- Mellemvægget, mastik-klæber
- Indkapsling af bl.a. kabler, ledninger, splejsninger.
- Selvslukkende, temperatur område -55° C til 110° C
- Krympetemp.: Fra +120° C
- Gennemslagsspænding: 15kV/mm min
- Længder af 1,2mtr.
- Salgsenhed: 12 stk., gerne assorteret

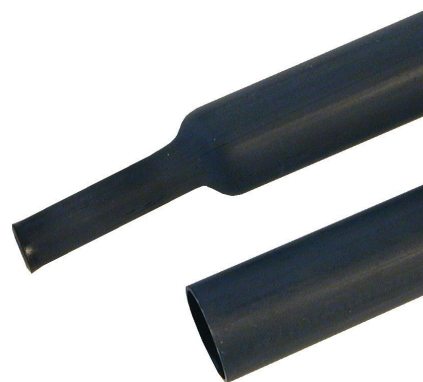

Ø	Krympefaktor	Varenr.	Pris Dkr
12	3:1	870400	kr. 80,58
20	3:1	870750	kr. 131,58
30	3:1	871100	kr. 157,08
34	3:1	871300	kr. 161,16
40	3:1	871500	kr. 218,28
45	3:1	871700	kr. 237,66
54	3:1	872050	kr. 242,76
70	3:1	872750	kr. 293,76
93	3:1	873500	kr. 405,96
120	3:1	874000	kr. 508,98

**[NEO-WRAP 1250]**

- Krympetape, mastikkklæber
- Sort, 10 mtr. rulle, krympfaktor 2:1

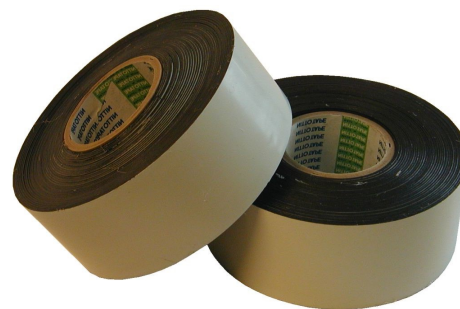

Bredde	Varenr.	Salgsenhed	Pris pr. rulle Dkr
50	1011050	6	kr. 228,48
100	1011100	4	kr. 454,92
150	1011150	2	kr. 684,42
200	1011200	2	kr. 911,88
300	1011300	1	kr. 1.365,78

## [DFFR MINIBOX]

- Flexibel, uden klæber.
- Indkapsling af bl.a. kabler, ledninger, splejsninger.
- Selvslukkende.
- Krympetemp.: Fra +100° C
- Gennemslagsspænding: 15KV/mm min
- Krympefaktor 2:1



Ø (mm)	Længde (m)	Varenr.	Pris Dkr
1,6	10	700012	kr. 111,18
2,4	10	700024	kr. 111,18
3,2	10	700032	kr. 111,18
4,8	9	700048	kr. 111,18
6,4	8	700064	kr. 111,18
9,5	6	700095	kr. 111,18
12,7	6	700127	kr. 111,18
19,1	5	700191	kr. 111,18
25,4	3	700254	kr. 111,18

## [DFUM MINIBOX]

- Flexibel, sort, dobbeltvægget, hotmelt klæber.
- Indkapsling af bl.a. kabler, ledninger, splejsninger.
- Selvslukkende, temperatur område -55° C til 110° C
- Krympetemp.: Fra +120° C
- Gennemslagsspænding: 20KV/mm min
- Krympefaktor 3:1



Ø (mm)	Længde (m)	Varenr.	Pris Dkr
3,0	5,0	800301	kr. 186,66
4,5	4,0	800451	kr. 186,66
6,0	3,5	800601	kr. 186,66
9,0	3,0	800901	kr. 186,66
12,0	2,5	801201	kr. 186,66

**[DURASEAL]**

- Vandtæt kabelsko og rørsamler
- Leveres i pakninger af 100 stk.



Farve	Størrelse (mm <sup>2</sup> )	Varenr.	Pris pr. stk. Dkr
Rød	0,5 - 1,5	890110	kr. 3,47
Blå	1,5 - 2,5	890111	kr. 3,57
Gul	2,5 - 6,0	890112	kr. 4,49

**[DUOFLEX]**

- Vandtætte tinmuffer
- Leveres i pakninger af 100 stk.



Farve	Størrelse (mm <sup>2</sup> )	Varenr.	Pris pr. stk. Dkr
Klar	0,1 - 0,5	890901	kr. 3,98
Rød	0,5 - 1,0	890902	kr. 4,28
Blå	1,5 - 2,5	890903	kr. 4,59
Gul	2,5 - 4,0	890904	kr. 4,90
Grå	4,0 - 6,0	890905	kr. 5,51

## KONTAKT OS DIREKTE



Boas Laursen  
20 83 60 36



Jørn Nørgaard  
52 23 91 91



Jesper Kaster  
20 32 60 32



Mogens Eskildsen  
40 68 00 74



Ole Ejstrud  
52 23 77 74

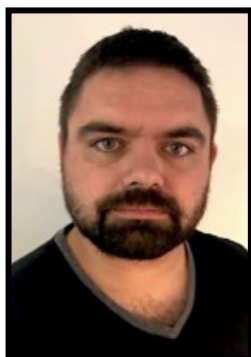

Lasse Olsen  
22 22 41 71



Filial: Håndværkervej 16, Roskilde  
40 55 60 33

Lene Haus Vej 17B - 7430 Ikast  
Vest 75773400 - Øst 56663400 - Fax: 75773401  
[www.diaflex.dk](http://www.diaflex.dk) - [diaflex@diaflex.dk](mailto:diaflex@diaflex.dk)

# NYHED

## DPH3500 Hybrid Boremotor fra Cardi.biz Italien

Diaflex A/S er officiel importør af Cardi Motor siden 2014. Cardi Motor har i år verdenspremiere på Hybrid Boremotor (3420W), der med Diamond Pulse Tech kan bore i beton med/ eller uden brug af vand.

DPH3500 leveres med CDP 520 RIG indbygget med vibrationsdæmpende håndtag. Ring for en demo. DPH3500 er fremtiden.



## DBH3000 Verdensnyhed fra Cardi.biz Italien

DBH3000 er det sidste skud på stammen af innovative løsninger fra Cardi Motor. DBH3000 er en kolossal kraftig 3000W, håndholdt eller monteret på Rig.

DPH3000 med Diamond Pulse Tech er løsningen – også når der skal bores uden vand i beton. Byggeriet i morgen vil efterspørge løsning for tørboring i beton. DBH3000 og DPH3500 fra Diaflex er svaret. Ring i dag.



# SERVICECENTER FOR CARDI OG WEKA

## VI AFHENTER OG LEVERER

Diaflex er importør og aut. servicecenter af Cardi Maskiner. Lasse Olsen er også et godt valg for jer til at reparere Weka, og de fleste andre maskiner, der bruges af bore- og skærefolket.

Ring trygt til Lasse 22 22 41 71  
- I kender vores service



**Diaflex A/S**

Lene Haus Vej 17B, 7430 Ikast  
75773400  
www.diaflex.dk

**Diaflex A/S** Filial

Håndværkervej 16, 4000 Roskilde  
56663400  
www.diaflex.dk

