



Diaflex®

28år - siden 1994

SE BAGSIDEN

NYHED

DPH3500 Hybrid Boremotor fra Cardi.biz Italien
Diaflex A/S er udflytningsselskab af Cardi.biz Italien 2014. Cardibiz er et af de mest innovative og pålidelige boremotorproducenter i verden. Pålidelighed og sikkerhed er de vigtigste værdier for Cardi.biz. DPH3500 er en hybrid boremotor med et robust og kompakt design. Den er ideel til brug i byggebranchen og til professionelle brugere.

DBH3000 Verdensnyhed fra Cardi.biz Italien
DBH3000 er den sidste model på markedet af innovative borer fra Cardi.biz. Den er en hybrid boremotor med et robust og kompakt design. Den er ideel til brug i byggebranchen og til professionelle brugere.

SERVICECENTER FOR CARDI OG WEKA
VI AFHENTER OG LEVERER

Diaflex er importer og udflytningsselskab af Cardi.biz Italien. Lene Olsen er ansvarlig for salg og service. Ring til Lene Olsen på telefonnummeret 75 77 34 00.



 Diaflex A/S
 Diaflex A/S Filial

IKAST
75 77 34 00

ROSKILDE
56 66 34 00

NU TILBAGE

• Construction Materials
• Reinforced Concrete
• Granit

• Cast Iron
• Metal
• Iron

INCISOR
ALL WHAT YOU NEED TO CUT IN ONE SAW... EVEN IRON WON'T RESIST...

* Spørg efter den.



DIAMANTBOR • RENOVERING AF BOR KERNE-
BOR MASKINER • STANDERE • GULVSKÆRE-
MASKINER • VÆGSAVE • GULVSLIBNING •
DIAMANTKLINGER • INDUSTRISTØVSUGERE

Diaflex A/S

Lene Haus Vej 17B, 7430 Ikast

75 77 34 00

diaflex@diaflex.dk • www.diaflex.dk

Diaflex A/S Filial

Håndværkervej 16, 4000 Roskilde

56 66 34 00

Kære kunde

Diaflex har siden 1994 været udbyder af europæisk fremstillet Diamantværktøj som Cardi Motor, Carbodiam, Maker og Mikea – alle med høj kvalitet

I Roskilde har vi Service, Lager og Serviceværksted indenfor Diamantværktøj, og maskiner.

Med Jan og Lasse møder du en samlet erfaring i boring og skæring på mere end 40 år.

En erfaring dit firma kan fordel af ved korrekt valg af diamantværktøj og ved service og vedligehold af maskiner

Kontakt derfor trygt Jan på **40556033** eller Lasse på **22224171**.



SERVICECENTER FOR CARDI OG WEKA

VI AFHENTER OG LEVERER

Diaflex er importør og aut. servicecenter af Cardi Maskiner. Lasse Olsen er også et godt valg for jer til at reparere Weka, og de fleste andre maskiner, der bruges af bore- og skærefolket.

Ring trygt til Lasse 22 22 41 71
- I kender vores service

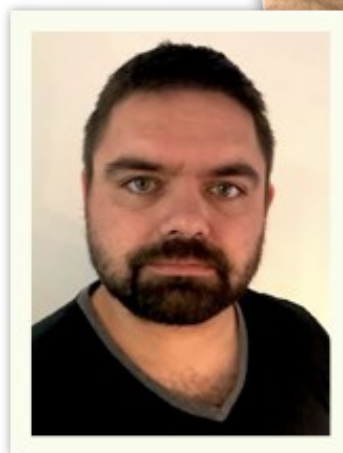



Filial: Håndværkervej 16, Roskilde
56 66 34 00

DIAFLEX KATALOG 2022

Dette katalog er beregnet for vores kunder indenfor dansk håndværk og industri. På de følgende sider præsenteres en stor del af vores program - primært indenfor diamantværktøj og maskiner, samt tape og krympeflex.

Diaflex har siden 1994 været aktør på dette marked, og har fra starten forenet service, kvalitet og en fair pris for at kunne give kunderne den fulde pakke.

Stor gensidigt loyalitet har vi kvitteret for med stor tak. Mere end 28 år i branchen er derfor også jeres garanti for at vi i de næste mange år fortsat er et sikker valg, når kvalitet og service har betydning. Diaflex har fra starten været baseret på produkter fra europæiske producenter. Brands som Carbodiam (Belgien); Mikea, Maker og Cardi alle fra Italien, og senest Sept Tools fra Frankrig. Alle er på hvert deres felt markedsledende og blandt de mest innovative i markedet.

Europæisk leverandører foretrækkes. Den korte afstand fra nabolandene sikre hurtig forsyning, når det må kræves. De opfylder naturligvis de ufravigelige EU normer, og er vores kunders garanti og forsikring, hvis uheldet måtte være ude.

Diaflex har firmadomicil midt i Jylland, nærmere bestemt Ikast, hvor vi siden 2014 har haft til huse med mere 600m2 lagerhal og butik. På Sjælland har vi filial i Roskilde.

På landevejen har vi 6 landsdækkende sælgere, der sammen med personale på lager og kontor, opretholder virksomhedens serviceprofil.

Ring endelig for besøg:

Jesper Kaster	Jørn Nørgaard	Lasse Olsen	Jan Christiansen	Mogens Eskildsen
20 32 60 32	52 23 91 91	22 22 41 71	40 55 60 33	40 68 00 74

VELKOMMEN,
Mogens Eskildsen
40 68 00 74

Roskilde Afdeling
56 66 34 00



BESØG VORES BUTIK PÅ LENE HAUS VEJ 17B ▪ 7430 IKAST
ELLER HÅNDVÆRKERVEJ 16 ▪ 4000 ROSKILDE



1 - Diamantbor

Vådbor, tørbor, adaptere, forlængere, slaganker, tilbehør i øvrigt

Side 7 - 30



2 - Renovering af bor

Segmenter, råbor

Side 31 - 39



3 - Boremaskiner

Diamantboremaskiner, standere, tilbehør
El - kædesav CARDI

Side 40 - 50



4 - SEPT-Tools

Side 50 - 54



5 - Diamantklinger

Håndholdte maskiner og skærebørde

Side 55 - 65



6 - Diamantklinger

Gulvsavsmaskiner

Side 66 - 75



7 - Diamantklinger

Vægsavsmaskiner

Side 76 - 77



8 - Diamantslibning

Skiver, slibemaskiner

Side 78 - 95

9 - Tape & Krympeflex

Tape, krympeflex, tinmuffer

Side 96 - 103



Diaflex

Diaflex A/S
Lene Haus Vej 17B, 7430 Ikast
75 77 34 00
www.diaflex.dk - diaflex@diaflex.dk

Diaflex A/S Filial
Håndværkervej 16, 4000 Roskilde
56 66 34 00

- Armeret beton
- Hurtig start—høj output
- Let at centrere - selvcentrende profil
- Segmenthøjde: 10mm
- Nyttelængde Ø15 - 32: 350mm - Gevind: 1/2"
- Nyttelængde Ø34 - 41: 450mm - Gevind: 1/2"



Ø	Varenr.	Segment-bredde	Kode
8	206293	2,0	DFK08
10	206295	2,0	DFK10
12	206297	2,0	DFK12
14	206299	2,0	DFK14
15	206300	2,5	DFK15
16	206301	2,5	DFK16
18	206302	2,5	DFK18
20	206303	2,5	DFK20
22	206304	2,5	DFK22
24	206305	2,5	DFK24
25	206306	2,5	DFK25
26	206307	2,5	DFK26
28	206308	2,5	DFK28
30	206309	2,5	DFK30
32	206310	2,5	DFK32
35	206311	3,0	DFK35
36	206312	3,0	DFK36
38	206313	3,0	DFK38
40	206314	3,0	DFK40
41	206315	3,0	DFK41
42	206316	3,5	DFK42
52	206317	3,5	DFK52



FCJC - TORNADOR Continuous Rings

- Armeret beton
- Nyttelængde: 350mm - Gevind: 1/2"
- Højt output
- Segmenthøjde: 10mm
- Kvik start-up
- Effektiv afkøling 2 x 2 vandveje



Ø	Varenr.	Segment-bredde	Kode
10	206201	2,0	FCJC0001
12	206202	2,0	FCJC0002
13	206203	2,0	FCJC0003
14	206204	2,0	FCJC0004
15	206115	2,5	FCJC0005
16	206116	2,5	FCJC0006
18	206118	2,5	FCJC0007
20	206120	2,5	FCJC0008
22	206122	2,5	FCJC0009
24	206124	2,5	FCJC0011
25	206125	2,5	FCJC0012
26	206126	2,5	FCJC0013
28	206128	2,5	FCJC0014
30	206130	2,5	FCJC0015
32	206132	2,5	FCJC0016
35	206135	2,5	FCJC0018
36	206136	2,5	FCJC0019
38	206138	2,5	FCJC0020
40	206140	2,5	FCJC0021
41	206141	2,5	FCJC0022

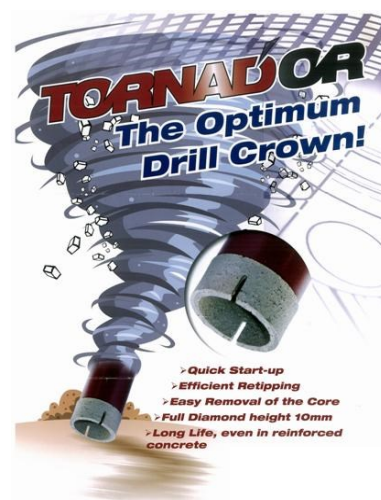

FJM - Tyndvægget

- Byggematerialer
- Nyttelængde: 450mm - Gevind: 5/4" *
- Segmenthøjde: 10mm
- Højt output



Ø	Varenr.	Segment-bredde	Kode
51	157303	2,5	FJMC0048
56	157304	2,5	FJMC0049
61	157305	2,5	FJMC0050
66	157306	2,5	FJMC0051
71	157307	2,5	FJMC0052
76	157308	2,5	FJMC0053
81	157309	2,5	FJMC0054
86	157310	2,5	FJMC0055
91	157311	2,5	FJMC0056
101	157312	2,5	FJMC0057
111	157314	2,5	FJMC0058
116	157315	2,5	FJMC0059
121	157316	2,5	FJMC0060
126	157317	2,5	FJMC0061
131	157318	2,5	FJMC0062
141	157319	2,5	FJMC0063
151	157320	2,5	FJMC0064
161	157321	2,5	FJMC0065
171	157322	2,5	FJMC0066
181	157323	2,5	FJMC0067
191	157324	2,5	FJMC0068
200	157325	2,5	FJMC0069

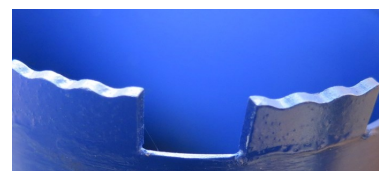
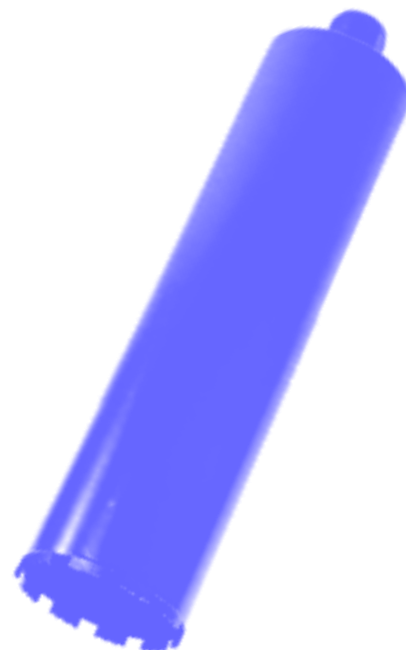

Double point PIXI



- Hurtig boring
- Armeret beton
- Gammel beton



Ø	Varenr.		Segment- bredde	Kode
51	157848	PIXI	3,5	FVLC0001PX
56	157849	PIXI	3,5	FVLC0002PX
61	157850	PIXI	3,5	FVLC0003PX
66	157851	PIXI	3,5	FVLC0004PX
71	157852	PIXI	3,5	FVLC0005PX
76	157853	PIXI	3,5	FVLC0006PX
81	157854	PIXI	3,5	FVLC0007PX
86	157855	PIXI	3,5	FVLC0008PX
91	157856	PIXI	3,5	FVLC0009PX
101	157857	PIXI	3,5	FVLC0011PX
106	157858	PIXI	3,5	FVLC0012PX
111	157859	PIXI	4,0	FVLC0014PX
121	157860	PIXI	4,0	FVLC0016PX
126	157861	PIXI	3,5	FVLC0017PX
131	157862	PIXI	4,0	FVLC0020PX
141	157865	PIXI	4,0	FVLC0022PX
151	157867	PIXI	4,0	FVLC0023PX
161	157872	PIXI	4,0	FVLC0025PX
171	157875	PIXI	4,0	FVLC0027PX
181	157876	PIXI	4,0	FVLC0029PX
200	157878	PIXI	4,0	FVLC0033PX
219	157880	PIXI	4,0	FVLC0035PX
225	157882	PIXI	4,0	FVLC0053PX
250	157884	PIXI	4,6	FVLC0037PX
299	157886	PIXI	4,6	FVLC0039PX
350	157888	PIXI	4,6	FVLC0041PX
399	157890	PIXI	4,6	FVLC0043PX
451	157892	PIXI	4,6	FVLC0045PX
499	157895	PIXI	5,0	FVLC0048PX
550	157896	PIXI	5,0	FVLC0049PX
599	157898	PIXI	5,0	FVLC0051PX

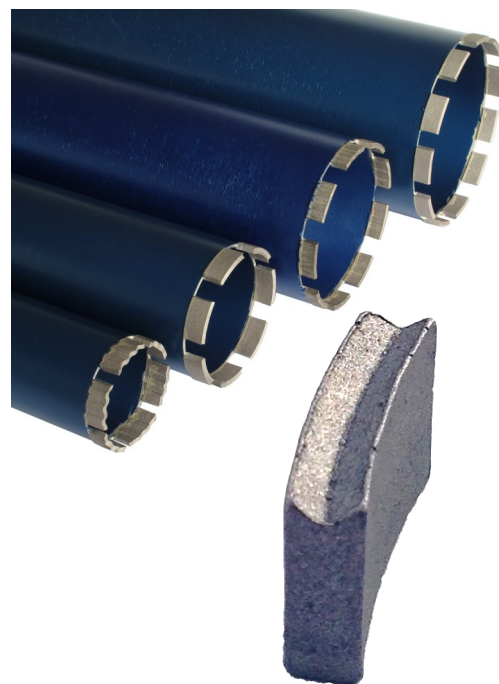

Vandopsamlingsring
- se tilbehør side 20

Double point 5/4"



- Hurtig boring
- Armeret beton
- Gammel beton

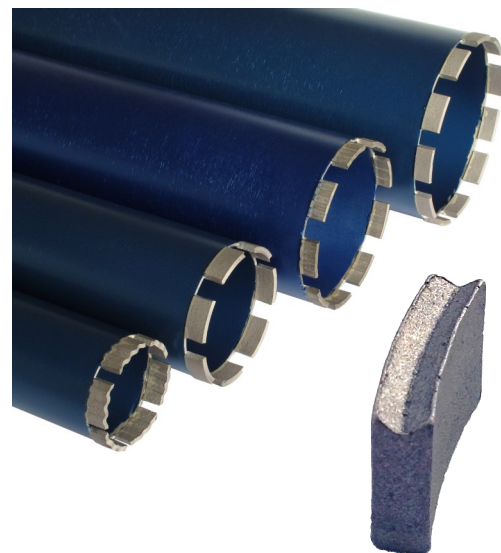

CARDI 183 - Motor T2000 Me-14 + L180 stander
2000W - Kapacitet Ø32 til Ø202
Integreret udsugningssystem.

Se side 40 - 49

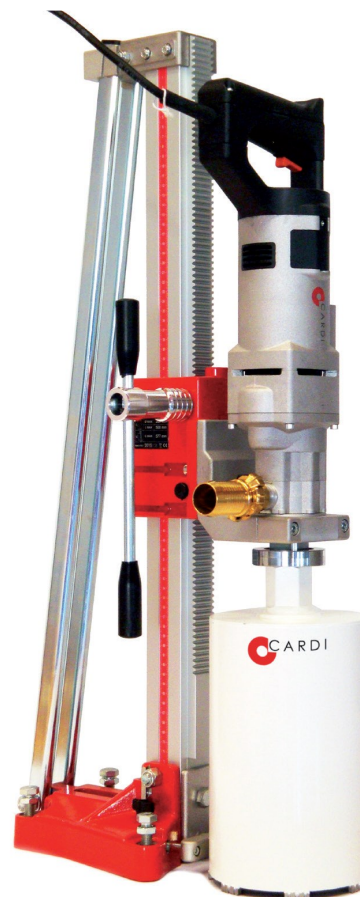

Ø	Varenr.	Segment- bredde	Kode	
51	157900	5/4"	3,5	FVLC0001
56	157901	5/4"	3,5	FVLC0002
61	157902	5/4"	3,5	FVLC0003
66	157903	5/4"	3,5	FVLC0004
71	157904	5/4"	3,5	FVLC0005
76	157905	5/4"	3,5	FVLC0006
81	157906	5/4"	3,5	FVLC0007
86	157908	5/4"	3,5	FVLC0008
91	157909	5/4"	3,5	FVLC0009
101	157911	5/4"	3,5	FVLC0011
106	157912	5/4"	3,5	FVLC0012
111	157913	5/4"	4,0	FVLC0014
121	157914	5/4"	4,0	FVLC0016
126	157915	5/4"	3,5	FVLC0017
131	157918	5/4"	4,0	FVLC0020
141	157921	5/4"	4,0	FVLC0022
151	159723	5/4"	4,0	FVLC0023
161	157925	5/4"	4,0	FVLC0025
171	157927	5/4"	4,0	FVLC0027
181	157928	5/4"	4,0	FVLC0029
200	157935	5/4"	4,0	FVLC0033
219	157937	5/4"	4,0	FVLC0035
225	157939	5/4"	4,0	FVLC0053
250	157941	5/4"	4,6	FVLC0037
299	157943	5/4"	4,6	FVLC0039
350	157945	5/4"	4,6	FVLC0041
399	157947	5/4"	4,6	FVLC0043
451	157949	5/4"	4,6	FVLC0045
499	157952	5/4"	5,0	FVLC0048
550	157953	5/4"	5,0	FVLC0049
599	157955	5/4"	5,0	FVLC0051



Ø	PIXI	5/4"	Anbefalet antal platter
76	F12074	F11074	5
138	F12136	F11136	10
186	F12184	F11184	12
226	F12224	F11224	16
276	F12274	F11274	18
341	F12339	F11339	21

[RONDA STØVSUGER]

- Effekt: 2550 W
- Vægt: 46 / 48 kg
- Mål: Højde 132 cm
- Leveres komplet med slange og div. mundstykker

Vare	Varenr.
RONDA 2000 - Støvsuger 2550 W, Højde 132 cm	407010

RONDA 2000

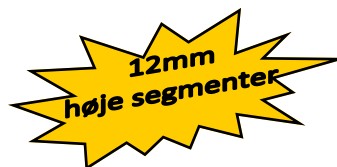

FJPC SHARKOR - Hard Concrete

- TurboStart (Selvskærpene segmenter)
- Bølgede sider = mindre friktion, højere hastighed
- Armeret beton og flint
- Højt output
- Nyttelængde på bor: 450mm - Gevind: 5/4"
- Segmenter er 12mm høje > 50% længere levetid
- Segmentlængde: 24mm

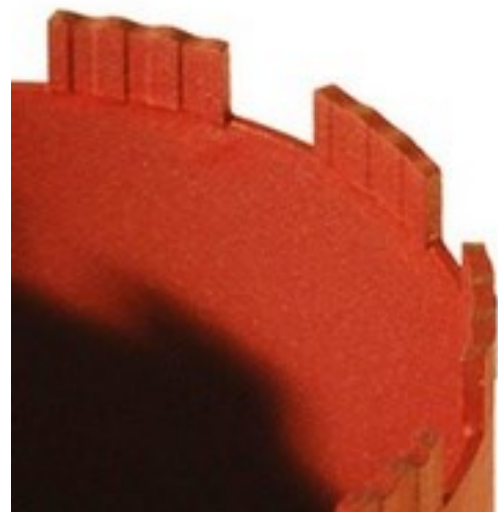

Ø	Varenr.	Segment- bredde	Kode
51	206615	3,5	FJPC2002
56	206616	3,5	FJPC2004
61	206617	3,5	FJPC2006
66	206618	3,5	FJPC2008
71	206619	3,5	FJPC2010
76	206620	3,5	FJPC2012
81	206621	3,5	FJPC2014
86	206622	3,5	FJPC2016
91	206623	3,5	FJPC2018
96	206624	3,5	FJPC2020
101	206625	3,5	FJPC2022
106	206626	3,5	FJPC2025
111	206627	4,0	FJPC2028
121	206628	4,0	FJPC2031
126	206629	4,0	FJPC2034
131	206630	4,0	FJPC2036
141	206631	4,0	FJPC2039
151	206632	4,0	FJPC2043
161	206633	4,0	FJPC2046
171	206634	4,0	FJPC2049
181	206635	4,0	FJPC2052
200	203636	4,0	FJPC2054
219	206637	4,0	FJPC2056
250	206638	4,6	FJPC2058
299	206639	4,6	FJPC2060
351	206641	4,6	FJPC2062
399	206642	5,0	FJPC2064
451	206643	5,0	FJPC2066
499	206644	5,0	FJPC2068

Roof Top - Hard Concrete



- Long Life
- Armeret beton
- Gammel beton
- Segmenthøjde: 11,5mm
- Segmentlængde: 24mm



**DIAFLEX
ANBEFALER**



Ø	Varenr. 5/4"	Varenr. Pixi	Segment-bredde
51	100101	100201	3,5
56	100102	100202	3,5
61	100103	100203	3,5
66	100104	100204	3,5
71	100105	100205	3,5
76	100106	100206	3,5
81	100107	100207	3,5
86	100108	100208	3,5
91	100109	100209	3,5
96	100110	100210	3,5
101	100111	100211	3,5
106	100112	100212	3,5
111	100113	100214	4,0
121	100114	100216	4,0
126	100118	100217	4,0
131	100115	100218	4,0
141	100122	100220	4,0
151	100123	100221	4,0
161	100125	100222	4,0
171	100127	100224	4,0
181	100129	100226	4,0
200	100133	100230	4,0
220	100135	100235	4,0
250	100137	100238	4,6
299	100140	100240	4,6
351	100141	100241	4,6
399	100144	100244	5,0
451	100146	100246	5,0
499	100148	100248	5,0

CARDI 189



Se side xx

DRILL 5C 

- Segmenthøjde: 9,5mm
- Hurtig boring
- Nyttelængde 450 mm - Gevind 5/4"
- Armeret beton, gl. beton



Ø	Varenr.	Segment- bredde
51	157502	3,5
56	157504	3,5
61	157506	3,5
66	157508	3,5
71	157510	3,5
76	157512	3,5
81	157514	3,5
86	157516	3,5
91	157518	3,5
101	157522	3,5
106	157526	3,5
111	157529	3,5
121	157532	4,0
126	157535	4,0
131	157537	4,0
141	157540	4,0
151	157542	4,0
161	157545	4,0
171	157548	4,0
181	157551	4,0
200	157553	4,0
219	157556	4,0
250	157558	4,0
299	157560	4,6
351	157565	4,6
399	157567	4,6
451	157569	5,0
499	157571	5,0

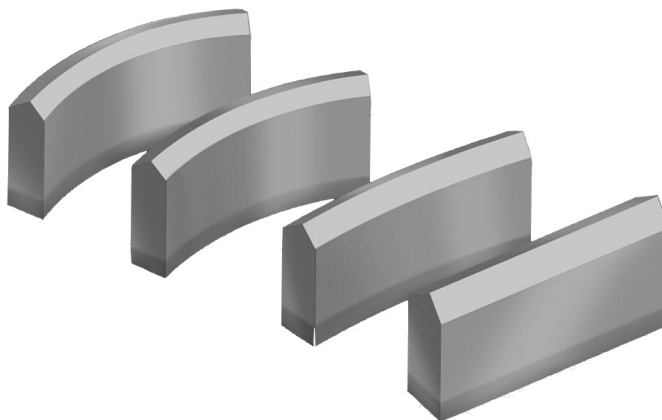

[FAC Wavor - Asfalt]



- TurboStart (Selvskærpene segmenter)
- Asfalt
- Nyttelængde: Ø>48: 450mm - Gevind: 5/4"
- Segmenthøjde: 10mm
- Segmentlængde: 24mm



Ø	Varenr.	Antal Segmenter	Segment-bredde	Kode	Pris Dkr
81	157626	7	3,5	FAC1007	kr. 1.936,98
86	157627	7	3,5	FAC1008	kr. 2.142,00
91	157628	9	3,5	FAC1009	kr. 2.408,22
101	157630	9	3,5	FAC1011	kr. 2.476,56
106	157631	9	3,5	FAC1012	kr. 2.511,24
111	157633	10	4,0	FAC1014	kr. 2.819,28
121	157635	10	4,0	FAC1016	kr. 2.870,28
126	157637	10	4,0	FAC1018	kr. 2.939,64
131	157639	11	4,0	FAC1020	kr. 3.127,32
141	157641	13	4,0	FAC1022	kr. 3.705,66
151	157643	13	4,0	FAC1024	kr. 3.744,42
161	157646	14	4,0	FAC1027	kr. 4.057,56
171	157649	14	4,0	FAC1030	kr. 4.194,24
181	157652	14	4,0	FAC1033	kr. 4.258,50
200	157656	15	4,0	FAC1037	kr. 4.657,32
219	157658	15	4,0	FAC1039	kr. 5.496,78
250	157660	18	4,6	FAC1041	kr. 6.336,24
299	157662	22	4,6	FAC1043	kr. 7.887,66
326	157664	22	4,6	FAC1045	kr. 8.525,16
351	157666	23	4,6	FAC1047	kr. 8.787,30
399	157668	28	4,6	FAC1049	kr. 10.659,00
451	157670	30	4,6	FAC1051	kr. 12.257,34
499	157673	33	5,0	FAC1054	kr. 13.940,34



FJMC - Tyndvægget

- Byggematerialer
- Nyttelængde: 300mm - Gevind: 5/4" *
- Segmenthøjde: 10mm
- Højt output



Ø	Varenr.	Segment-bredde	Kode
56	157406	2,5	FJMC0002
61	157407	2,5	FJMC0003
66	157408	2,5	FJMC0028
71	157409	2,5	FJMC0029
76	157410	2,5	FJMC0006
81	257411	2,5	FJMC0030
86	157412	2,5	FJMC0031
91	157413	2,5	FJMC0032
101	157414	2,5	FJMC0010
106	157415	2,5	FJMC0033
111	157418	2,5	FJMC0034
121	157419	2,5	FJMC0036
126	157420	2,5	FJMC0061
131	157421	2,5	FJMC0062
141	157422	2,5	FJMC0063
151	157423	2,5	FJMC0064
161	157424	2,5	FJMC0065
171	157425	2,5	FJMC0066
181	157426	2,5	FJMC0067
191	157427	2,5	FJMC0068
200	157428	2,5	FJMC0069

* også i 1/2" gevind



[TØRBOR MED SUG]

- Tørboring med sug - Ingen støvgéner
- Minimalt oprydning efter boring
- Mursten, let beton
- Nyttelængde: 150mm



Ø	Varenr.	Antal segmenter
68	15750	3
82	15753	4
92	15755	4
102	15757	4
107	15758	4
112	15759	4
122	15761	4
127	15762	4
132	15763	4
142	15765	5
152	15767	5
162	15769	5
186	15774	6

[RONDA STØVSUGER]

- Effekt: 1100 W
- Vægt: 15 kg
- Mål: Højde 80 cm
- Leveres komplet med slange og div. mundstykker

Vare	Varenr.
RONDA 200H - Støvsuger tør 1200W, Højde 80 cm	407000

RONDA 200H

[TØRBOR]

- Mursten, let beton
- Nyttelængde: 160mm



Ø	Varenr.	Antal segmenter
32	15402	3
37	15403	3
42	15404	3
47	15405	3
52	15406	3
57	15407	3
62	15408	3
68	15409	3
72	15410	4
77	15411	4
82	15412	4
87	15413	4
92	15414	4
102	15416	4
107	15417	4
112	15418	4
122	15420	4
132	15422	4
138	15423	4
142	15424	5
152	15426	5
162	15428	5
167	15430	5

[ADAPTERE] [STØV-OPSAMLERE] [SUGEHOVED] [VANOPSAMLINGS-RINGE]

			
Indv. 5/4" - udv. Pixi Varenr. 15010	Indv. 5/4" - indv. 1/2" Varenr. 15015	Indv. 5/4" - udv. M30 Varenr. 15020	Indv. Pixi - udv. 5/4" Varenr. 15025
			
Indv. Pixi - indv. 1/2" Varenr. 15024	Udv. Pixi - udv. 1/2" Varenr. 15030	Udv. 5/4" - Udv. 1/2" Varenr. 15032	Udv. 1/2" - Udv. M16 Varenr. 15035
			
Udv. 5/4" gevind- M16 indv. gevind for pit til boremaskine - kan bruges både med vand og sug. Varenr. 15080	Indv. 1/2" - Udv. 6-kantet fæste m/ vandstuds Varenr. 09990	STØV OPSAMLER - 1"1/4 UNC (f) - 1"1/4 UNC (m) - 1/2 G (f) Varenr. 390726	STØV OPSAMLER - PIXI (f) - PIXI (m) Varenr. 390752
VANDOPSAMLINGSRINGE (WSR) 	Forsegling skive f. WSR m/ skala 	Gummi-forsegling f. WSR 	
380010 - Ø100mm 380011 - Ø150mm 380012 - Ø200mm 380013 - Ø250mm 380014 - Ø300mm 380015 - Ø350mm	380040 f. Ø100 380041 f. Ø150 380042 f. Ø200 380043 f. Ø250 380044 f. Ø350	380020 - pr./mtr. 380021 sæt f. Ø100 380022 sæt f. Ø150 380023 sæt f. Ø200 380024 sæt f. Ø250 380025 sæt f. Ø350	

[Bolte] [Anker]

			
<p>Bolt m/fjeder (L) 15340</p>	<p>Bolt u/ fjeder (L) 15341</p>	<p>Bolt M12 m/flytbar disc 15342</p>	<p>K50 Fjeder bolt size M 15343</p>
<p>Anker skruer</p> 		<p>Fastgørelse bolte / Snapgevind</p> 	
<p>15305 K50 / 65 15306 K50 / 65 HW 15307 K50 / 165 15308 K50 / E250 15309 K50 / 300 15310 K50 / 400 15311 K50 / 600 15312 K50 / 800 15313 K50 / 1000 15314 K50 / 130 M12 15315 K50 / 155 M12 15316 K50 / 170 M12</p>		<p>15320 M16 / B 15/250 15321 M16 / B 15/300 15322 M16 / B 15/400 15323 M16 / B 15/500 15324 M16 / B 15/800 15325 M16 / B 15/1000 15326 M12 / B 15/250 15327 M12 / B 15/300 15328 M12 / B 15/500 15329 M12 / B 15/800 15330 M12 / B 15/1000</p>	
			
<p>Bolt u/fjeder (M) 15344</p>	<p>Bolt u/fjeder (S) 15345</p>	<p>Bolt m/fjeder (S) 15346</p>	<p>Kontra møtrik f. MFP B15 15347</p>

[Bolte]

			
MFP-Multimonterings plate 15348	MFP-Multimonterings plate m/ vacuum 15349	Låse skrue for MFP SW13 15390 B15/150 15391 B15/200	15392 B15/250 15393 B15/300 15394 B15/350
			
AHV - Løfte hængsel/2 tons 15331 AHL2	AHV - Løfte hængsel/2 tons 15332 AHR2	AHV - Løfte hængsel/500kg. 15333 AHVSG	Reserve bolt f. AHV 15334 AHVM
			
K50-Lift manuel Størrelse 122x33cm, Swingpipe 61cm. Max bæreevne 408kg. Inkl. Wheelpipe og swingpipe	408020	K50 - Sharpening plate for diamant kernebor og diamant klinger 320x320x55	15335

[PROTECTOR]

		Tilbehør Protector 1.0 Net f. Protector 1.0 408011 Kr. 596 Hose f. Protector 1.0 408012 Kr. 1826 10 mtr. w/ connections Hose f. waste water 10 mtr. 408013 Kr. 3025 1", inkl. 2xGeka-coupling Hose f. waste water 5 mtr. 408014 Kr. 1722 1", inkl. 2xGeka-coupling	
Protector 1.0	408010		
		Nut f. telescope ratchet 1/2" 13mm 	
Telescope ratchet 1/2"	408015	Kort	408016
		Lang	408017
			
Multi pillar 1,55 - 2,90 mtr. 150-450 kg	408025	Core catcher 300x300	15336
Multi pillar 2,0 - 3,75 mtr. 70-450 kg.	408026	Core catcher 500x500	15337
Tripod for Multi pillar -450 kg.	408027	Core catcher 300x1000	15338
		Core catcher 500x1000	15339

[SLAGANKRE]

[SNAPGEVIND]

[HAMMERBOR]

[SLAGDORNE]

		 <p>x 200</p> <p>+</p>
<p>Slaganker M12 udv. 16mm (50 stk.) - Beton Varenr. 15374</p>		<p>Slagankersæt til beton Varenr. 101100</p>
	<p>Slagankersæt m/250 stk. M12 + Dorn Varenr. 15365</p>	<p>Slagankersæt til beton Varenr. 101100</p>
		
<p>Snapgevind M12 220/25mm Varenr. 15351</p>	<p>Snapgevind M12 250/80mm Varenr. 15352</p>	
		
	<p>Hammerbor SDS+ Ø16mm 160/100 Varenr. 15387</p>	<p>Dorn for slaganker Varenr. 15381 M12 Varenr. 15382 M16</p>

[FASTNØGLER]

[KOBBERINGE]

[SPÆNDSØJLE]

[BÆREHÅNDTAG]

		
<p>FASTNØGLER Vnr. 965010 SW22 Vnr. 965011 SW24 Vnr. 965012 SW32 Vnr. 965002 SW41 Vnr. 965013 SW46</p>	<p>KOBBERINGE For let afmontering af bor Salgsenhed : 50 stk./pose Varenr. 965001</p>	<p>CARDIFACILE Hurtig afmonterings enhed for kernebor Universel til brug for standard 5/4" Varenr. 390707</p>
		
<p>BOR UDTRÆKKER - Let udtræk af fastkilede bor Varenr. 199999</p>	<p>BÆREHÅNDTAG Varenr. 108510 5/4" Varenr. 108515 Pixi</p>	<p>SPÆNDSØJLE 170 - 300cm Belastning 500 kg Mulighed for fin justering Varenr. 965000</p>
		
	<p>Trykspand 10 L. 3 bar Varenr. 390755</p>	<p>Trykspand 10 L. 6 bar Varenr. 390756</p>

[FORLÆNGERE] [RENOVERING]

		
<p>Forlængere 1/2" - sort stål 13100 100mm 13200 200mm 13300 300mm 13400 400mm 13500 500mm</p>	<p>Forlængere 5/4" -sort stål 14100 100mm 14200 200mm 14300 300mm 14400 400mm 14500 500mm</p>	<p>Forlængere PIXI -sort stål 14610 100mm 14620 200mm 14630 300mm 14640 400mm 14650 500mm</p>
 <p style="text-align: center;">LETVÆGT</p>		
<p>Forlængere 5/4" Aluminium 14101 100mm 14201 200mm 14301 300mm 14401 400mm 14501 500mm</p>	<p>Borkapmaskine (Depositum, udlån) 100820</p>	<p>Sølvstænger 101014 dagspris 101015 - høj temperatur dagspris</p>
		
<p>Magneter 101000 0,75 / 1,00 101010 0,50 / 1,25</p>	<p>Fluss 101011 0,5kg</p>	<p>Sortimentsboks til segmenter 101112</p>

[FORLÆNGERE] [PIT] [CENTERBOR] [ADAPTERE]

		
<p>Forlængere M16 - sort stål</p> <p>14810 100mm 14820 200mm 14830 300mm 14850 500mm</p>	<p>Indv. 1/2" - Udv. 6-kantet fæste m/ vandstuds</p> <p>Varenr. 09990</p>	<p>Usv. 1/2" - Udv. M16</p> <p>Varenr. 15035</p>
		
<p>Sugehoved til tømmer</p> <p>Varenr. 15700</p>	<p>Pit til tømmer M16</p> <p>15040 SDS+ 100mm 15046 SDS+ 220mm 15042 6-kantet 100mm 15047 6-kantet 220mm 15048 6 kantet 350mm</p>	<p>Centerbor</p> <p>15400 f. tømmer 160mm 15708 f. tømmer m. sug</p>

CARDIFACILE - KVIK KERNEBOR AFMONTERINGS ENHED 5/4"

Varenr.	KOMPATIBILITET
506102	Håndholdt kernebor
505355	Alle Cardi kernebor

**KOBBER RING FOR 5/4" BOREHOVED**

HØJ TYKKELSE (4 mm) OG LANG LEVETID

Varenr.	KOMPATIBILITET
501818	Alle Cardi kernebor med 5/4"

**CENTER GUIDE ENHED FOR HÅNDHOLDT BORING**

For 5/4" kernebor

Varenr.	KERNEBOR GEVIND
504840	5/4" + 1/2"
504841	5/4" + HUL Ø19mm

**CENTRERINGSENHED FOR HÅNDHOLDT BORING**

Med innovativ roterende ende- for borehoved 5/4" L=250mm

Varenr.	KERNEBOR GEVIND
506149	5/4" + 1/2"
506151	5/4" + HUL Ø19mm

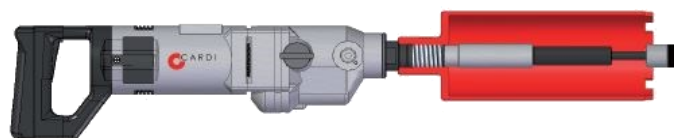
**MOTORMONTERINGS PLADER**

Varenr.	BESKRIVELSE
505035	Plade for montering af håndholdte kernebor: Borestander L 160—L 180
505036	Plade for montering af håndholdte kernebor: Borestander L 200 - L 250 - L 300
505040	4 huls motor monterings plade for borestander L 200
505039	6 huls motor monterings plade for borestander L 250 - L 300
504870	6 huls motor monterings plade for borestander C 520
505936	6 huls motor monterings plade for borestander C 600 - C600-1500
505937	Motor monterings plade for borestander CARDI 805 - CARDI 1005



AFSTANDSSKIVER

Varenr.	BESKRIVELSE
502545	H = 20 mm - 4 huller
502296	H = 50 mm - 4 huller
506148	H = 30 mm (L 160 - L 180)
506132	H = 30 mm + collar 60 mm L 200 - L 250 - L 300
501899	H = 20 mm - 6 huller
501852	H = 45 mm - 6 huller
501654	H = 60 mm - 6 huller
506107	H = 80 mm - 6 huller
501634	H = 110 mm - 6 huller
506106	H = 37 mm CARDI 805 / 1005
506105	H = 105 mm CARDI 805 / 1005

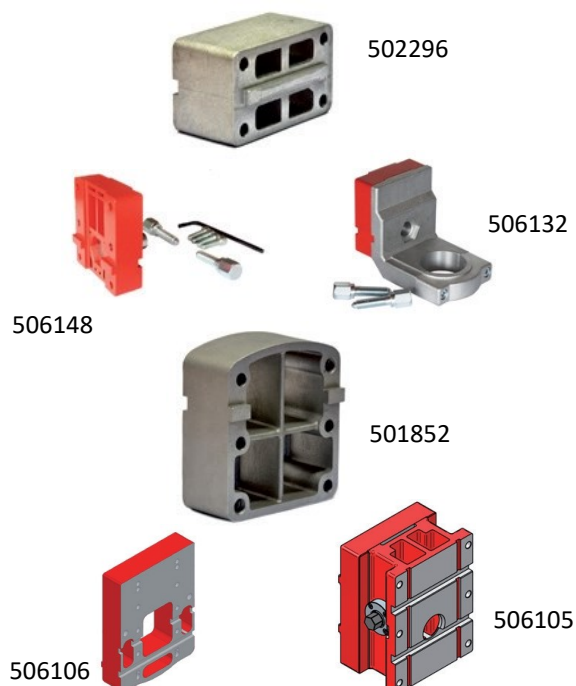
**STØVSUGER**

Varenr.	BESKRIVELSE
ASP 1	Støvsuger 1200W - ekstra 230V stik til elværktøj



ASP 1

VAKUUM-FASTGØRELSE

For boring maks diameter 250 mm

Varenr.	BESKRIVELSE
505066	Vakuumbase Kit 250x250 mm (styrke ~300 kg)
505063	Vakuumbase Kit 300x330 mm (styrke ~500 kg)
PV 4-S	Vakuumpumpe Med sikkerhedstank

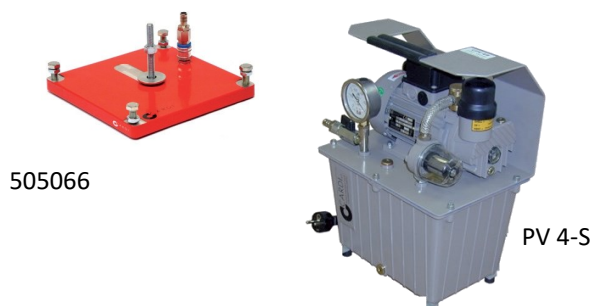
**ANKERMONTERING**

Varenr.	BESKRIVELSE
503628	Snapgevind
15374	50 slaganker M12 u/krave
15381	Dorn for slaganker M12



VANDOPSAMLINGSSÆT FOR KERNEBOR

Maks Diameter 150 og 250 mm

Varenr.	BORE STANDSMODELLER	Ø mm
505062	L160 - L180 - L200 - L250 - L300	250
503999	C520 - C600 - C600-1500	250
501712	(ekstra gummi skive)	250
505061	L160 - L180 - L200 - L250 - L300	150
501111	(ekstra gummi skive)	150

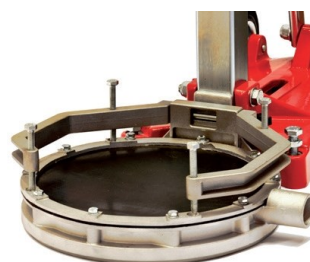

505061



501111

VÆGKLEMME MONTAGE ENHED

Varenr.	BESKRIVELSE
503183	Montering af borestander i f.eks. vinduesåbning

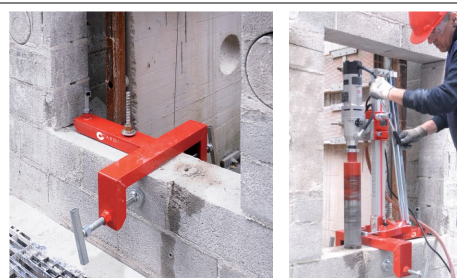

503183

CORNER JACK

Til boring glat med væg (eller gulv) og ind i hjørnerne

Varenr.	BESKRIVELSE
502305	Kompatibel med alle CARDI håndholdte kerneboremaskiner og med boremotor T1 200-EL

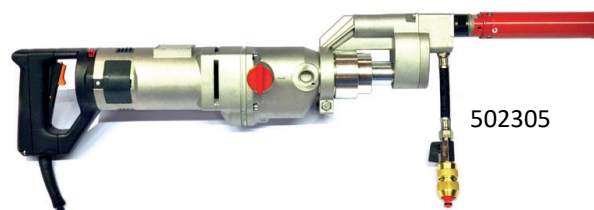

502305

SKINNE FASTGØRELSESTILBEHØR

Varenr.	BORE STANDSMODELLER
505064	L160 - L180 - L200 - L250 - L300
503160	C520 - C600 - C600-1500

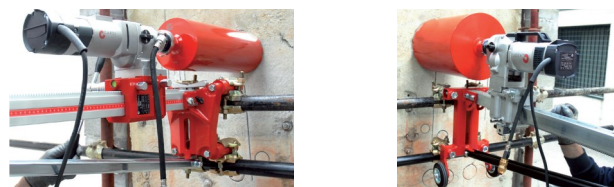
**RESERVEDELE / TILBEHØR**

Varenr.	BESKRIVELSE
504568	Vand slange sæt til kernebore motor
500101	Vand-stop vand slange forbindelse
506050	Vand indløb og ventil til ME kernebore motorer
504207	Støvsuger forbindelse
502143	Håndtag til håndholdte Kernebore motor
503940	Kul sæt for CARDI kernebore motor
503392	PRCD 10mA 220V 16A

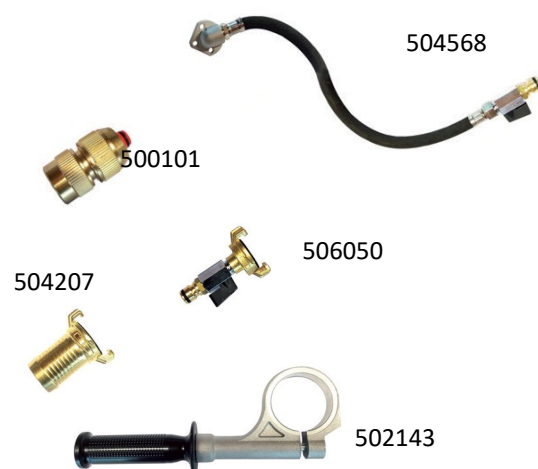

504568

500101

506050

504207

502143

[FCJ - Tornador]



- Armeret beton, granit
- Høj output
- Let at centrere - selvcentrende profil
- Segmenthøjde: 10 mm
- Motor =<2000W
- Effektiv afkøling 2 x 2 vand veje



Ø	Varenr.	Segment- bredde	Kode
10	100073	2,0	FCJS0001
12	100074	2,0	FCJS0002
13	100075	2,0	FCJS0003
14	100076	2,0	FCJS0004
15	100077	2,5	FCJS0005
16	100078	2,5	FCJS0006
18	100079	2,5	FCJS0007
20	100080	2,5	FCJS0008
22	100082	2,5	FCJS0009
24	100083	2,5	FCJS0011
25	100084	2,5	FCJS0012
26	100085	2,5	FCJS0013
28	100086	2,5	FCJS0014
30	100087	2,5	FCJS0015
32	100088	2,5	FCJS0016
35	100090	2,5	FCJS0018
36	100091	2,5	FCJS0019
38	100092	2,5	FCJS0020
40	100093	2,5	FCJS0021
41	100094	2,5	FCJS0022

[DFS30 - Continuous Rings] 

- Armeret beton, granit
- Høj output
- Let at centrere - selvcentrende profil
- Segmenthøjde: 10 mm
- Motor =<2000W
- Effektiv afkøling 2 x 2 vand veje



Ø	Varenr.	Segment- bredde	Kode
8	206396	2,0	
10	206397	2,0	
12	206398	2,0	
14	206399	2,0	
15	206400	2,5	
16	206401	2,5	
18	206402	2,5	
20	206403	2,5	
22	206404	2,5	
24	206405	2,5	
25	206406	2,5	
26	206407	2,5	
28	206408	2,5	
30	206409	2,5	
32	206410	2,5	
35	206411	3,0	
38	206413	3,0	
40	206414	3,0	
42	206416	3,5	
52	206426	3,5	

[Double Point]



- TurboStart (Selvskærpande segmenter)
- Armeret beton og flint
- Højt output
- Segmenthøjde: 10mm + 2
- Salgsenhed: 50 stk./pose



Ø	Varenr.	Segment-bredde (mm)	Segment højde (mm)	Segment-længde (mm)	Kode
48-55	105531	3,5	10+2	24	FVLD001
56-62	105532	3,3	10+2	24	FVLD002
63-72	105533	3,3	10+2	24	FVLD003
73-86	105534	3,5	10+2	24	FVLD004
87-108	105535	3,5	10+2	24	FVLD005
109-147	105537	3,5	10+2	24	FVLD007
109-147	105538	4,0	10+2	24	FVLD008
148-235	105539	4,0	10+2	24	FVLD009
148-235	105540	4,6	10+2	24	FVLD010
> 235	105542	5,0	10+2	24	FVLD012
> 235	105543	5,6	10+2	24	FVLD013
> 235	105546	6,1	10+2	24	FVLD014

[FRTD - Roof Top Long Life]



- Lang levetid
- Armeret beton
- Gammel beton



Ø	Varenr.	Segment-bredde (mm)	Segment højde (mm)	Segment-længde (mm)
56-62	105504	3,5	12	24
63-72	105506	3,5	12	24
73-86	105508	3,5	12	24
87-108	105510	3,5	12	24
109-147	105511	3,5	12	24
109-147	105512	4,0	12	24
148-235	105514	4,0	12	24
148-235	105515	4,6	12	24
> 236	105517	5,0	12	24
> 236	105518	5,6	12	24

[FAD Wavor - Asfalt]



- TurboStart (Selvskærpnde segmenter)
- Asfalt, basaltic beton, aluminatcement
- Segmenthøjde: 10mm
- Segmentlængde: 24mm
- Salgsenhed: 50 stk./pose



Ø	Varenr.	Segment- bredde (mm)	Segment højde (mm)	Segment- længde (mm)	Kode
50-55	106802	3,5	10	24	FAD1002
56-62	106804	3,5	10	24	FAD1004
63-72	106806	3,5	10	24	FAD1006
73-86	106808	3,5	10	24	FAD1008
87-108	106810	3,5	10	24	FAD1010
109-147	106811	3,5	10	24	FAD1011
109-147	106812	4,0	10	24	FAD1012
148-235	106813	3,5	10	24	FAD1013
148-235	106814	4,0	10	24	FAD1014
148-235	106815	4,6	10	24	FAD1015
> 235	106816	4,6	10	24	FAD1016
> 235	106817	5,0	10	24	FAD1017
> 235	106818	5,6	10	24	FAD1018

[1/2" RÅBOR]

- Nyttelængde: 400mm



Ø	Varenr.	Væg-tykkelse
17	10017	1,5
19	10019	1,5
21	10021	1,5
23	10023	1,5
25	10025	1,5
27	10027	1,5
28	10028	1,5
29	10029	1,5
30	10030	1,5
31	10031	1,5
32	10032	1,5
34	10034	1,5
35	10035	1,5
38	10038	1,5
39	10039	1,5
40	10040	1,5
41	10041	1,5
45	10045	1,5
50	10050	1,5
55	10055	1,5
60	10060	1,5
65	10065	1,5
70	10070	1,5
75	10075	1,5
80	10080	1,5
85	10085	1,5
90	10090	1,5
100	10100	1,5
110	10110	2,0

[5/4" RÅBOR]

- Nyttelængde: 400mm



Ø	Varenr.	Væg-tykkelse
40	11040	1,5
45	11045	1,5
50	11050	1,5
55	11055	1,5
60	11060	1,5
65	11065	1,5
70	11070	1,5
75	11075	1,5
80	11080	1,5
85	11085	1,5
90	11090	1,5
100	11100	1,5
105	11105	2,0
110	11110	2,0
120	11120	2,0
125	11125	2,0
130	11130	2,0
136	11136	2,0
140	11140	2,0
150	11150	2,0
160	11160	2,0
165	11165	2,0
170	11170	2,0
180	11180	2,0
184	11184	2,0
198	11198	2,0
210	11210	2,0
220	11220	2,0
230	11230	2,0
248	11248	2,0

[5/4" RÅBOR]

- Nyttelængde: 400mm / 450mm



Ø	Varenr.	Væg-tykkelse
260	11260	2,0
270	11270	2,0
280	11280	2,5
298	11298	2,5
323	11323	2,5
348	11348	2,5
380	11380	2,5
398	11398	2,5
420	11420	2,5
448	11448	2,5
498	11498	3,0
548	11548	3,0
598	11598	3,0
648	11648	3,0
698	11698	3,0

[5/4" RÅBOR]

- Forsheda-mål:

Ø	Varenr.	Væg-tykkelse
136	11136	2,0
184	11184	2,0
224	11224	2,5
274	11274	2,5

[PIXI RÅBOR]

- Nyttelængde: 400mm / 450mm



Ø	Varenr.	Væg-tykkelse
50	12050	1,5
60	12060	1,5
65	12065	1,5
70	12070	1,5
75	12075	1,5
80	12080	1,5
85	12085	1,5
90	12090	1,5
100	12100	1,5
105	12105	2,0
110	12110	2,0
120	12120	2,0
125	12125	2,0
130	12130	2,0
140	12140	2,0
150	12150	2,0
160	12160	2,0
165	12165	2,0
170	12170	2,0
180	12180	2,0
198	12198	2,0
210	12210	2,0
220	12220	2,0
232	12232	2,0
248	12248	2,0

[PIXI RÅBOR]

- Nyttelængde: 400mm



Ø	Varenr.	Væg-tykkelse
260	12260	2,0
270	12270	2,0
280	12280	2,5
298	12298	2,5
323	12323	2,5
348	12348	2,5
380	12380	2,5
398	12398	2,5
420	12420	2,5
448	12448	2,5
498	12498	3,0
548	12548	3,0
598	12598	3,0
648	12648	3,0
698	12698	3,0

[PIXI RÅBOR]

- Forsheda-mål:

Ø	Varenr.	Væg-tykkelse
136	12136	2,0
184	12184	2,0
224	12224	2,5
274	12274	2,5

[FLANGE]

Gevind	Varenr.	Antal huller
5/4"	15300	6
Pixi	15301	6





T2000 MS-13 HÅNDHOLDT KERNEBREMASKINE - TØR BORING

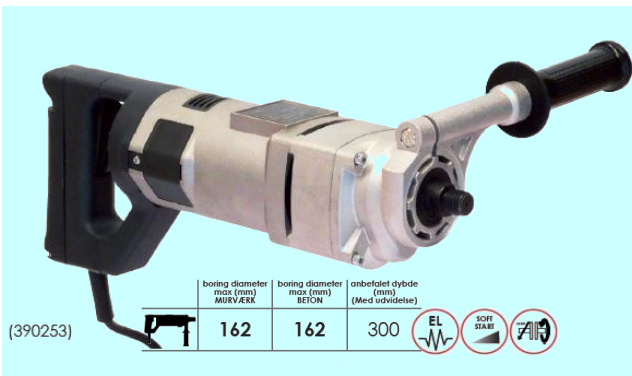

TEKNISKE SPECIFIKATIONER T2000 MS-13		
EFFEKT (230 V)	W	2000 (MAX 2200)
R.P.M. UBELASTET /BELASTET	R.p.m.	2000 / 1350
KAPACITET I MURVÆRK / ABRASIVE	Ø mm	32 - 162
KAPACITET I BETON	Ø mm	32 - 162
BORTILSLUTNING		M18 x 2,5
VÆGT	Kg	4,8
MEDFØLGENDE TILBEHØR		TRANSPORT KUFFERT

T2000 MA-14 HÅNDHOLDT KERNEBREMASKINE - TØR BORING STØVSUGNINGSSYSTEM



TEKNISKE SPECIFIKATIONER T2000 MA-14		
EFFEKT (230 V)	W	2000 (MAX 2200)
R.P.M. UBELASTET /BELASTET	R.p.m.	1400 / 960
KAPACITET I MURVÆRK / ABRASIVE	Ø mm	32 - 202
KAPACITET I BETON	Ø mm	32 - 162
BORTILSLUTNING		5/4"
VÆGT	Kg	5,6
MEDFØLGENDE TILBEHØR		TRANSPORT KUFFERT

T2000 ME-14 HÅNDHOLDT KERNEBREMASKINE TØR- & VÅDBORING MED STØVSUGNINGSSYSTEM

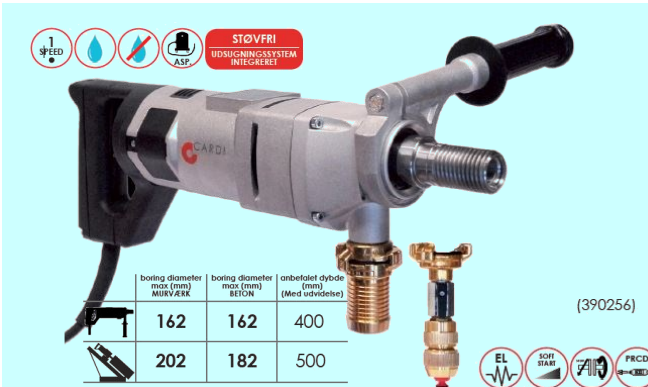

TEKNISKE SPECIFIKATIONER T2000 ME-14		
EFFEKT (230 V)	W	2000 (MAX 2200)
R.P.M. UBELASTET /BELASTET	R.p.m.	1400 / 960
KAPACITET I MURVÆRK / ABRASIVE	Ø mm	32 - 202
KAPACITET I BETON	Ø mm	32 - 162
BORTILSLUTNING		5/4"
VÆGT	Kg	5,6
MEDFØLGENDE TILBEHØR		TRANSPORT KUFFERT



T1 ME-EL

HÅNDHOLDT KERNEBREMASKINE TØR- & VÅDBORING
MED STØVSUGNINGSSYSTEM FOR INTENSIVT ARBEJDE



TEKNISKE SPECIFIKATIONER T1 ME-EL		
EFFEKT (230 V)	W	2200 (MAX 2650)
R.P.M. UBELASTET /BELASTET	G1	r.p.m. 750 / 530
	G2	r.p.m. 1800 / 1280
	G3	r.p.m. 2500 / 1780
KAPACITET I MURVÆRK / ABRASIVE	Ø mm	20 - 252
KAPACITET I BETON	Ø mm	20 - 202
BORTILSLUTNING		5/4"
VÆGT	Kg	7,3
MEDFØLGENDE TILBEHØR		TRANSPORT KUFFERT

CARDI 183

HÅNDHOLDT KERNEBREMASKINE MED STANDER



CARDI 189

HÅNDHOLDT KERNEBREMASKINE MED STANDER



TEKNISKE SPECIFIKATIONER T2000 ME-14 MED STANDER CARDI 183			TEKNISKE SPECIFIKATIONER T2000 ME-14 MED STANDER CARDI 189		
KERNEBREMOTOR MODEL		T2000 ME-14	KERNEBREMOTOR MODEL		T1 ME-EL
BORE STANDER MODEL		L 180	BORE STANDER MODEL		L 180
SØJLE TILT		45°	SØJLE TILT		45°
VÆGT (MOTOR + STANDER)	Kg	5,6 + 10	VÆGT (MOTOR + STANDER)	Kg	7,3 + 10
MEDFØLGENDE TILBEHØR (MOTOR)		TRANSPORT KUFFERT	MEDFØLGENDE TILBEHØR (MOTOR)		TRANSPORT KUFFERT
PRIS	kr.		PRIS	kr.	

CARDI 200

KERNEBOREMASKINE MED STANDER



CARDI 400

KERNEBOREMASKINE MED STANDER



TEKNISKE SPECIFIKATIONER

CARDI

			T1 200-EL	T6 375-EL
KERNEBOREMOTOR MODEL			T1 200-EL	T6 375-EL
BORE STANDER MODEL			L 200	C520
EFFEKT (230 V)		W	2200 (MAX 2500)	3420 (MAX 4400)
R.P.M. UBELASTET /BELASTET	G1	r.p.m.	540 / 385	350 / 230
	G2	r.p.m.	1300 / 920	800 / 520
	G3	r.p.m.	1800 / 1280	1475 / 965
KAPACITET I BETON - VÅD		Ø mm	30 - 200	30 - 400
BORTILSLUTNING			5/4" + 1/2"	5/4"
VÆGT		Kg	19	41
PRIS		kr.		

CARDI 500

KERNEBOREMASKINE MED STANDER



CARDI 501

KERNEBOREMASKINE MED STANDER



TEKNISKE SPECIFIKATIONER			CARDI 500	CARDI 501
KERNEBREMOTOR MODEL			T9 475-EL	T4 300-EL
BORE STANDER MODEL			C 520	C 600
EFFEKT (230 V)		W	3420 (MAX 4400)	3420 (MAX 4400)
R.P.M. UBELASTET /BELASTET	G1	r.p.m.	300 / 190	300 / 190
	G2	r.p.m.	560 / 370	560 / 370
	G3	r.p.m.	920 / 600	920 / 600
	G4	r.p.m.	1540 / 1000	1540 / 1000
KAPACITET I BETON - VÅD		Ø mm	25 - 500	25 - 500
BORTILSLUTNING			5/4"	5/4"
VÆGT		Kg	42	46
PRIS		kr.		

CARDI 605 - 3 faser 380/400V

KERNEBREMASKINE MED STANDER / VANDKØLET MOTOR

CARDI 805 - 3 faser 380/400V

KERNEBREMASKINE MED STANDER / VANDKØLET MOTOR



TEKNISKE SPECIFIKATIONER		CARDI 605	CARDI 805
KERNEBREMOTOR MODEL		FR 605	FR 805
BORE STANDER MODEL		C 520	C 600
EFFEKT (230 V)	W	4200 (MAX 5000)	6000 (MAX 7000)
R.P.M. UBELASTET /BELASTET	G1 r.p.m.	115	90
	G2 r.p.m.	185	195
	G3 r.p.m.	260	325
KAPACITET I BETON - VÅD	Ø mm	120 - 500	100 - 600
MAX KERNEBOR DIAMETER - U/AFSTANDSSTYKKE	Ø mm	452	566
MAX KERNEBOR DIAMETER - M/AFSTANDSSTYKKE inkl.	Ø mm	612 (506107)	640 (506106)
BORTILSLUTNING		5/4"	5/4"
VÆGT	Kg	50	67
PRIS	Dkr.		

C600 - 1500 EXTRA-LANG SØJLE

SERVO 520 / DA VINCI SERVO SEMI-AUTOMATISK FEEDING SYSTEM



CARDI C600-1500	
PASSER TIL ALLE CARDI MOTORER	
PRIS	

	SERVO 520	DA VINCI SERVO
PASSER TIL	C 520	C600, C600-1500, DA VINCI SYSTEM
SPECIFIKATIONER	BØRSTELØS MOTOR 24V-150W - KONTROL PANEL - FJERN KONTROL	
MAX BELASTNING	600 Kg	
PRIS	kr. 21.873,90	

CARDI PE 400

ELEKTRISK KLINGESAV - VÅDSKÆRING OGSÅ GLAT LANGS VÆG

CARDI PE 401

ELEKTRISK KLINGESAV TØRSKÆRING MED DUST EXTRACTION
GLAT VÅDSKÆRING TIL VÆG

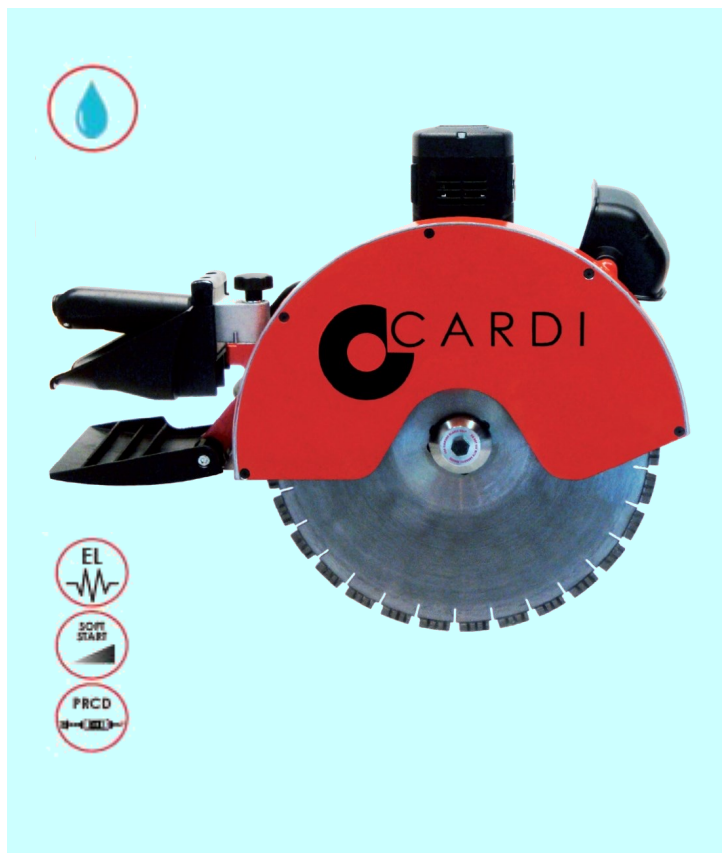

TEKNISKE SPECIFIKATIONER		PE 400-BL	PE 401-BL
EFFEKT (230 V)	W	3420 (MAX 4400 / 6 hp)	3420 (MAX 4400 / 6 hp)
R.P.M. UBELASTET /BELASTET	r.p.m.	2870 / 1880	2870 / 1880
KLINGE DIAMETER	mm	400	400
KLINGE CENTER HUL	mm	25,4	25,4
MAXIMUM SKÆRE DYBDE	mm	160 (135 med støv udsugning)	160 (135 med støv udsugning)
FLANGE FOR GLAT SKÆRING		incl. som standard	Incl. som standard
STØV UDSUGNINGS TILBEHØR		tilbehør	Incl. som standard
VÆGT	Kg	13	14,5
PRIS	kr.		

CARDI PIRANHA 125-SX

MURRILLEFRÆSER - TØRSKÆRING MED STØVSUGNINGSSYSTEM



TEKNISKE SPECIFIKATIONER		PH 125-SX
EFFEKT (230 V)	W	2000 (MAX 2200)
R.P.M. UBELASTET /BELASTET	r.p.m.	7900 / 5000
KLINGE DIAMETER (antal og diameter)		2 x 125 mm
KLINGE CENTER HUL	mm	22,2
RILLE MAXIMUM BREDDE	mm	43
RILLE MAXIMUM DYBDE	mm	138,5
VÆGT	Kg	13
PRIS	kr.	

CARDI AL 18.43

ELEKTRONISK MOTORSÅV - TØRSKÆRING AF BLOKKE



CARDI AL 22.53

ELEKTRONISK MOTORSÅV - TØRSKÆRING AF BLOKKE



TEKNISKE SPECIFIKATIONER		AL 18.43	AL 22.53
EFFEKT (230 V)	W	2000 (MAX 2200 / 2,95 hp)	2200 (MAX 2650 / 3,5 hp)
R.P.M. UBELASTET /BELASTET	r.p.m.	2850/ 1640	2800 / 1800
SVÆRD & HÅRD METAL KÆDE	cm	43	53
SAFTY BRAKE + TOTAL PROTECTION SYSTEM BY CARDI		JA	JA
KÆDE SMØRE METODE		KÆDESAV OLIE	KÆDESAV OLIE
VÆGT SVÆRD & KÆDE INKLUDERET	Kg	10	10,7
PRIS	kr.		

CARDI CD35.35

ELEKTRONISK DIAMANT MOTORSÅV - VÅDSKÆRING I BETON OG MARMOR



TEKNISKE SPECIFIKATIONER		CD35.35
EFFEKT (230 V)	W	3420 (MAX 4400 / 6 hp)
R.P.M. UBELASTET /BELASTET	r.p.m.	9400 / 6150
SKÆRE DYBDE	Mm	400
TOTAL PROTECTION SYSTEM BY CARDI		JA
KÆDE SMØRRELSE OG DIAMANT KØLING		VAND
VÆGT SVÆR OG KÆDE INKLUDERET	Kg	9
PRIS	kr.	

GIRAFO - Multihead og TURBO 7

GIRAFO & SEPT IU33 TURBO 7



GIRAFO

Orbital rotary head
Ø225 mm

Samlet pris:
Girafo + IU33 Turbo 7 + Orbital rotary head Ø225
+ System kuffert

Kr. 17383

TEKNISKE SPECIFIKATIONER		IU33 TURBO 7 H11	GIRAFO	ORBITAL ROTARY HEAD
CODE		S931603	S950937	S950939
EFFEKT (230 V)	W	1600		
AIRFLOW		330m ³ / h		
KAPACITET		33L		
LYDNIVEAU		< 70 db		
FILTERSYSTEM		H11 / H12		
SYSTEM			Rotary / orbital rotary	
DIAMETER HOVED	mm		165 / 225	225
VÆGT	Kg	9,3	2,5	
PRIS	kr.			

TILBEHØR		PRIS
S508640	System kuffert i kraftig plast	
S598114	Anti statisk støvsuger slange	
S598112	Adapter Ø40mm til IU33 W	

AIR JACKET - SCOURPIO

AIR JACKET - SCOURPIO

- FORDELER BELASTNING
- JUSTERBAR BALANCE



Leveres med
1 luftpumpe

TEKNISKE SPECIFIKATIONER		AIR JACKET - SCOURPIO	
Dimensioner	m	1,55 x 0,40 x 0,45	
MAX BELASTNING	Kg	10	
KABEL LÆNGDE	m	2,4	
VÆGT	Kg	6,9	
STØRRELSER - angiv		L - XL - XXL	
PRIS (\$495942)			

SLIDING BALANCER - GECKO

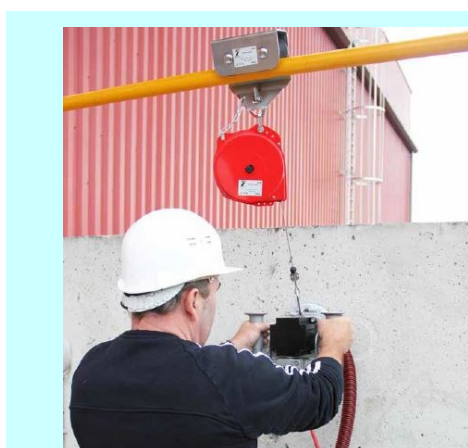

TEKNISKE SPECIFIKATIONER		SLIDING BALANCER - GECKO	
MAX BELASTNING	Kg	6 - 10	
KABEL LÆNGDE	m	2,4	
PRIS (\$495935)			



FOUINE—XB 135 / XB 165



TEKNISKE SPECIFIKATIONER		XB 135	XB 165
EFFEKT (230 V) output	W	1164	1552
HASTIGHED SPEED 1 / SPEED 2	rpm	3000 / 5500	2800 / 4800
VIBRATIONER	ms ²	0.22	0.22
LYDNIVEAU	db	62	62
BESKYTTELSE		IP 64	IP 64
MAX HØJDE m/ GAZELLE	M	4,2	4,2
MAX HØJDE m/ GAZELLOTO	M	4,6	4,6
DIAMETER HOVED	mm	135	165
MONTERING AF VÆRKTØJ		Patented	Patented Daisy bore
VÆGT	Kg	6,9	7,6
PRIS m/ Elektronisk boks	kr.		
PRIS m/ Elektronisk boks + depression controller	kr.		

MEDFØLGENDE STANDARD UDSTYR XB 135 og XB 165



PIC EPEICHE - Diamant bor Ø160mm med BRUSHLESS motor

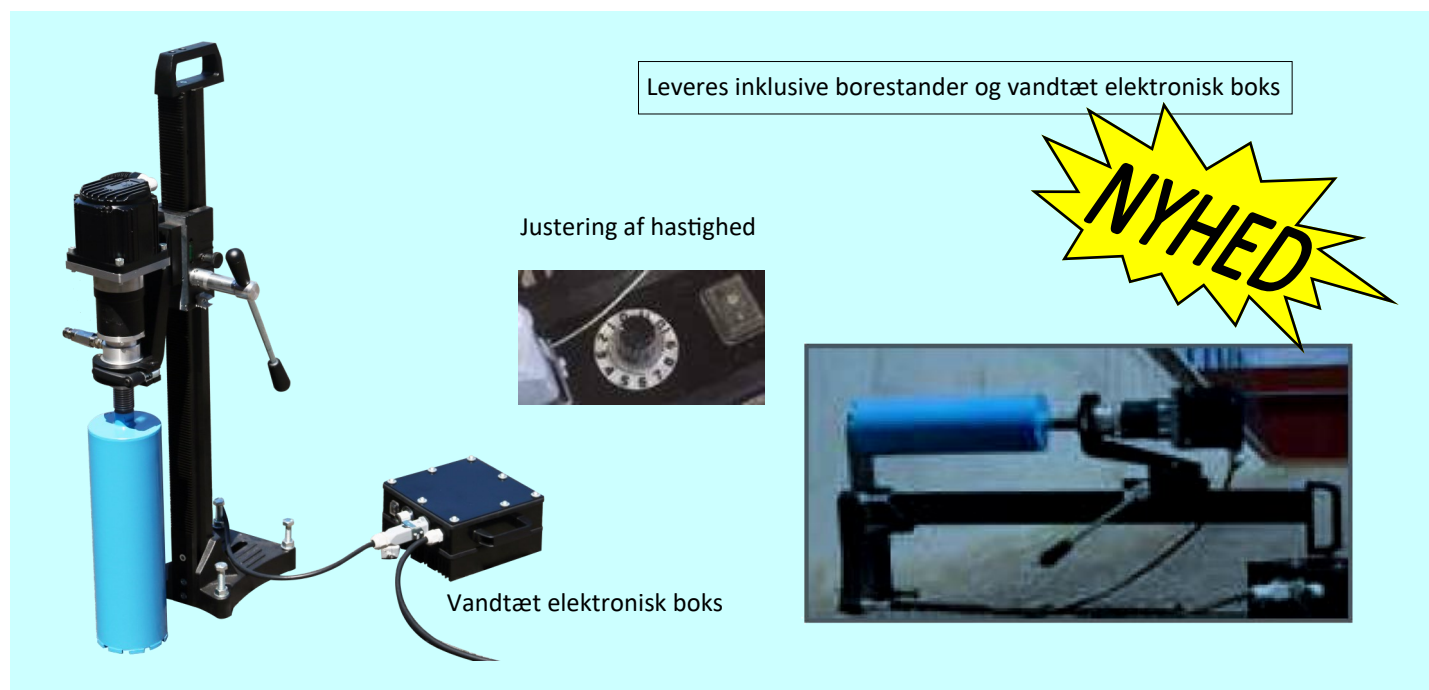

Leveres inklusive borestander og vandtæt elektronisk boks

Justering af hastighed



NYHED

Vandtæt elektronisk boks



TEKNISKE SPECIFIKATIONER	PIC EPEICHE	
EFFEKT (230 V) output	W	1600
HASTIGHED SPEED 1 / SPEED 2 / SPEED 3	rpm	400 / 550 / 700
VIBRATIONER	ms ²	0.27
BESKYTTELSE		IP 64
DIAMETER KERNEBOR (MAX)	mm	160
MONTERING AF VÆRKTØJ		5/4" eller 1/2 GAS
VÆGT	Kg	15,5
PRIS m/ BRUSLESS motor	kr.	
PRIS m/ BRUSLESS motor + depression controller m/ automatisk stop	Dkr.	

BRUSHLESS handheld crack chaser - TAUPE

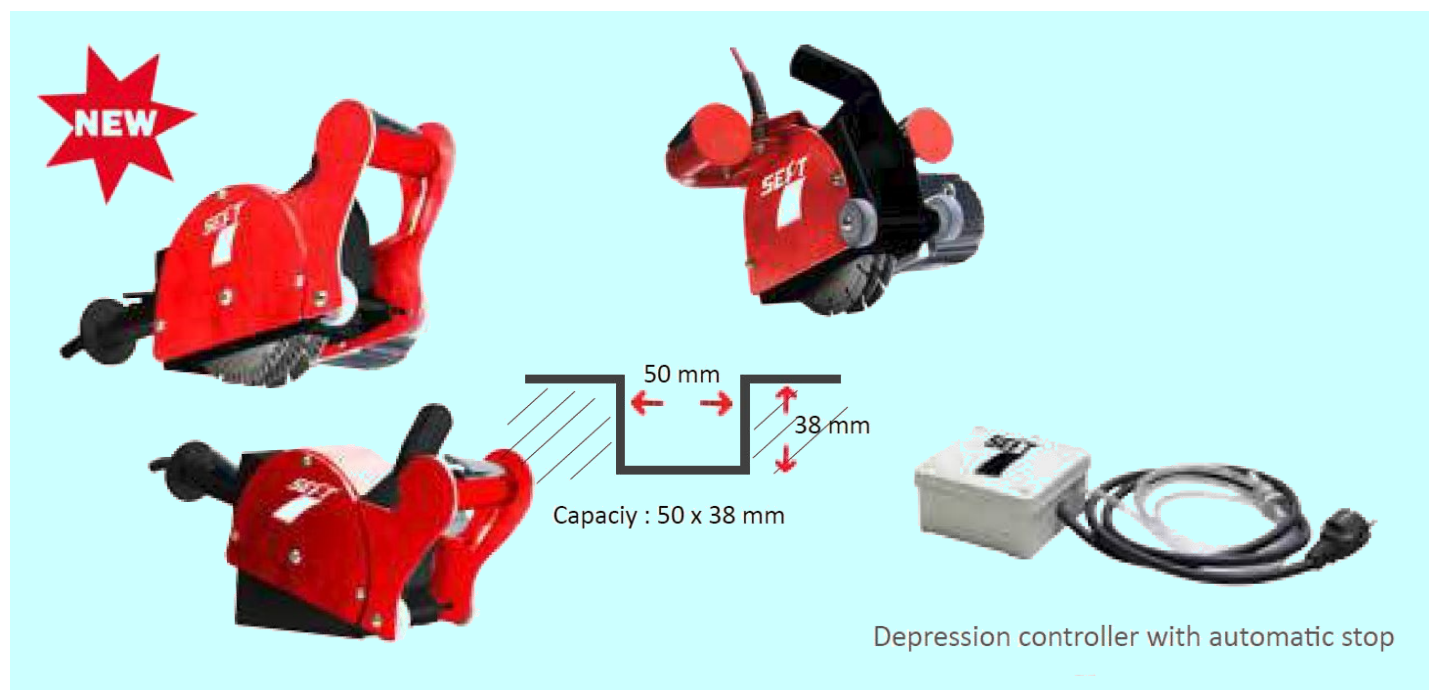

TEKNISKE SPECIFIKATIONER	TAUPE	
EFFEKT (230 V) output	W	1552
HASTIGHED SPEED 1 / SPEEED 2	rpm	2800 / 4800
VIBRATIONER	ms ²	0.38
BESKYTTELSE		IP 64
LYDNIVEAU	dB	59
KLINGE	Ø / mm	200
SKÆREDYBDE (MAX)	mm	38
VÆGT	Kg	17
PRIS m/BRUSLESS motor og elektronisk boks	kr.	
PRIS m/ BRUSLESS motor og elektronisk boks + depression controller m/ automatisk stop	kr.	

[INCISOR FS]

- TurboStart (Selvskærpemde segmenter)
- Intensiv skæring
- Granit, beton, byggematerialer, flint, armeret beton, wirenetforstærket beton
- Specielt udviklet til kompakte materialer
- Hurtigt snit
- Højt output, høj ydeevne

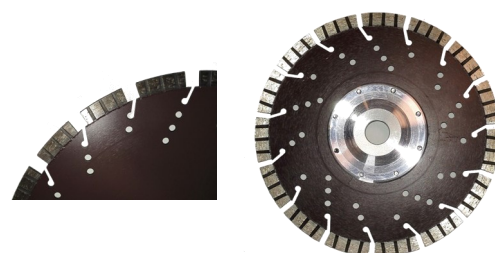

Incisor FS Ø230 m/flange

Ø	Hul	Varenr.	Kode
115	22,23	200331	
125	22,23	200332	
180	22,23	200333	
230	22,23	200334	
230	22,23	200330	m/ flange
300	20,0	200335	
300	25,4	200336	
350	20,0	200337	
350	25,4	200338	
400	20,0	200339	
400	25,4	200340	

[PAP - PANTERA]

- Alle byggematerialer
- Hurtig snit
- Universalklinge

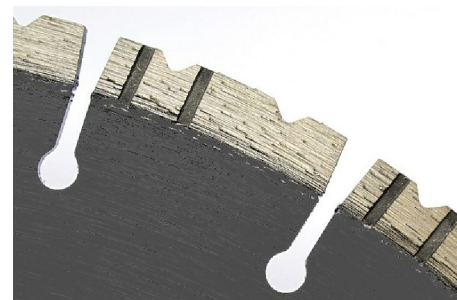

Ø	Hul	Varenr.	Antal Seg.	Segmentmål (l x h x b)	Kode
125	22,2	200010	10	30 x 10 x 2,4	PAPC001
150	22,2	200011	12	30 x 10 x 2,4	PAPC009
230	22,2	200012	16	38 x 10 x 2,6	PAPC002

[Diaflex blå]

- Armeret beton, flint beton, lintels
- Semi-abrasive materials, washed concrete
- Universalklinge

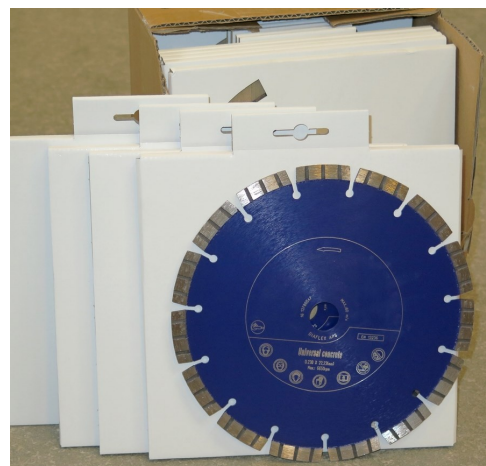

Ø	Hul	Varenr.	Segmentmål (l x h x b)	Kode
125	22,2	200450		
230	22,2	200455		
350	25,4	200460		
400	25,4	200470		

[DIAFLEX Orange - TMS]

- Limestone, betonfliser, mursten, letklinke-blokke
Beton blokke, naturlig sandsten



Ø	Hul	Varenr.	Antal Seg.	Segmentmål (l x h x b)	Kode
350	25,4	203890	24	40 x 10 x 3,2	TMS1002
400	25,4	203891	28	40 x 10 x 3,2	TMS1003
450	25,4	203892	32	40 x 10 x 4,0	TMS1004

[Diaflex Gul - MER]

- Alle byggematerialer, cut in turn
- Lejlighedsvis skæring i granit
- Universalklinge



Ø	Hul	Varenr.	Antal Seg.	Segmentmål (l x h x b)	Kode
125	22,2	200194	9	33 x 10 x 2,2	MER1007
150	22,2	200195	9	40 x 10 x 2,4	MER1008
180	22,2	200196	11	40 x 10 x 2,4	MER1009
230	22,2	200197	16	40 x 10 x 2,4	MER1010



[MMG] 

- Alle byggematerialer
- Intensiv skæring i granit
- Præcist og hurtigt snit

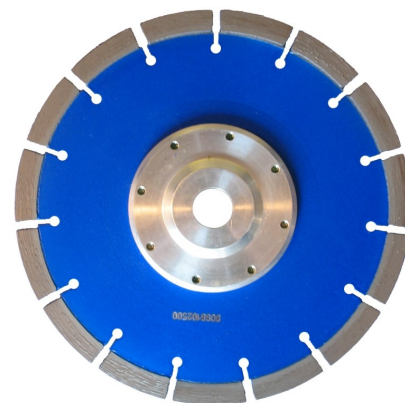
KLINGE MED FLANGE FOR TÆTSKÆRING

Ø	Hul	Varenr.	Antal Seg.	Segmentmål (l x h x b)
230	22,2	200043	16	40 x 13 x 2,6

[Diamantklunge Concave] 

- Beton
- Buet klinge til at skære kurver

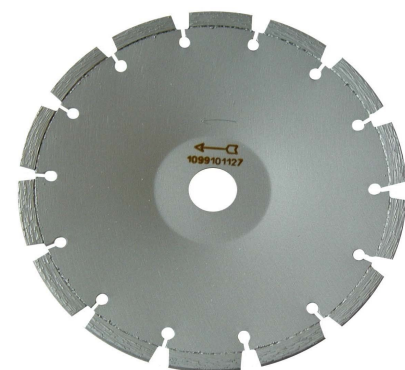
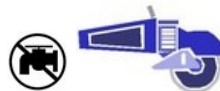

Ø	Hul	Varenr.	Antal Seg.	Segmentmål (l x h x b)
125	22,2	203103	14	20 x 7 x 2,2
180	22,2	203105	18	20 x 7 x 2,8

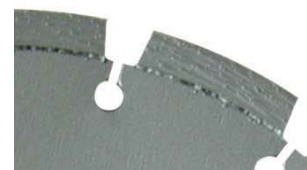
**[RAT - High Performance Silver]** 

- Rillefræsning
- Lintels, armeret beton, murværk, semi-abrasive materialer
- Hurtigt snit



Ø	Hul	Varenr.	Antal Seg.	Segmentmål (l x h x b)	Kode
125	22,2	200301	10	33 x 7,5 x 2,4	RAT1001
140	22,2	200302	11	33 x 7,5 x 2,4	RAT1002
150	22,2	200303	12	33 x 7,5 x 2,4	RAT1003
180	22,2	200304	12	40 x 7,5 x 2,4	RAT1004

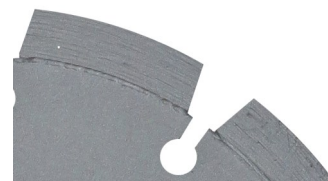

Leveres i pakker af 2 klinger. Den angivne pris er pr. klinge.

[EJR - Crack Abrasive] 

- Fjernelse af mørtel, rillefræsning i gulv, lægning af gulvvarme
- Abrasivt beton
- Højt output, høj ydeevne
- Vertikale segmenter for beskyttelse af stambladet
- Snitbredde: 7,5mm



Ø	Hul	Varenr.	Antal Seg.	Segmentmål (l x h x b)	Kode
125	22,2	200442	6	40 x 7,5 x 7,5	EJR0004

[EJC - Crack Compact] 

- Fjernelse af mørtel, rillefræsning i gulv, lægning af gulvvarme
- Hårdt beton, tæt beton
- Høj skærehastighed, høj ydeevne
- Vertikale segmenter for beskyttelse af stambladet
- Snitbredde: 7,5mm



Ø	Hul	Varenr.	Antal Seg.	Segmentmål (l x h x b)	Kode
125	22,2	200502	6	40 x 7,5 x 7,5	EJC0006

[EJF - Easy Cut Gold] 

- Bearbejdning af murværk, fjernelse af mørtel, skærer mursten
- Forskudte segmenter
- Hurtigt snit
- Vertikale segmenter for beskyttelse af stambladet
- Snitbredde: 7,5mm



Ø	Hul	Varenr.	Antal Seg.	Segmentmål (l x h x b)	Kode
125	22,2	200405	12	20 x 7,5 x 3,6	EJF0005

[TAS - Beton Dark Grey]

- Universel beton, murværk, kantsten, overliggere
- Hurtig, let skæring
- Høj ydelse

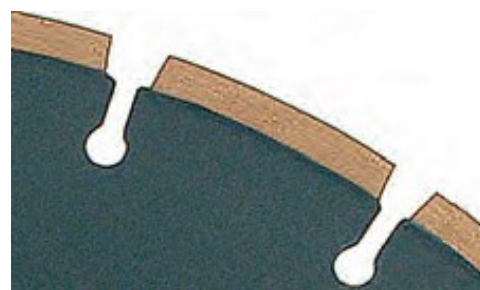
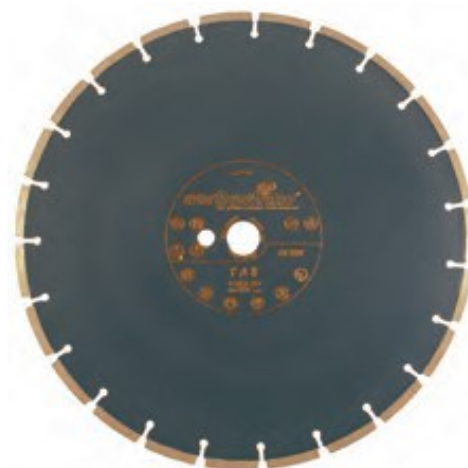

Ø	Hul	Varenr.	Antal Seg.	Segmentmål (h x b)	Kode
300	25,4/20	203851	18	40 x 13 x 2,8	TAS1301
350	25,4/20	203853	21	40 x 13 x 3,0	TAS1302
400	25,4	203854	24	40 x 13 x 3,2	TAS1303
450	25,4	203855	25	40 x 13 x 3,6	TAS1304
500	25,4	203856	30	40 x 13 x 3,6	TAS1305
600	25,4	203857	34	40 x 13 x 3,6	TAS1306
650	25,4	203858	36	40 x 13 x 3,6	TAS1307
700	25,4	203859	40	40 x 13 x 3,6	TAS1308

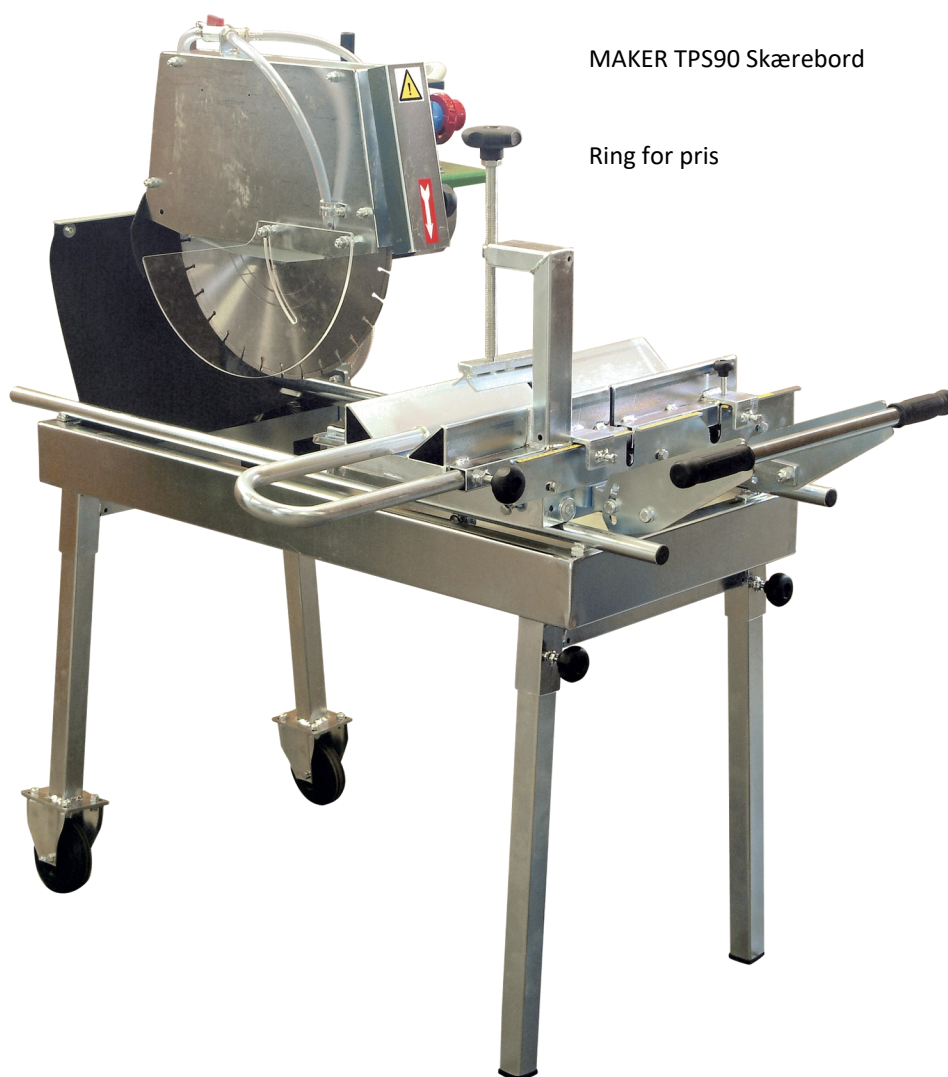

MAKER TPS90 Skærebord

Ring for pris

[DIAFLEX Orange - TMS]

- Limestone, betonfliser, mursten, letklinke-blokke
Beton blokke, naturlig sandsten



Ø	Hul	Varenr.	Antal Seg.	Segmentmål (l x h x b)	Kode
350	25,4	203890	24	40 x 10 x 3,2	TMS1002
400	25,4	203891	28	40 x 10 x 3,2	TMS1003
450	25,4	203892	32	40 x 10 x 4,0	TMS1004

[TME - Masonry Orange]

- Limestone, betonfliser, mursten, letklinke-blokke
Beton blokke, naturlig sandsten

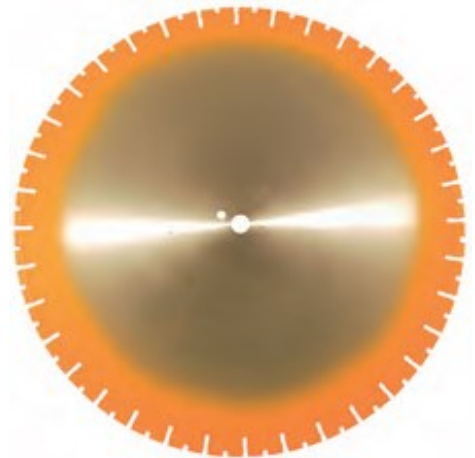

Ø	Hul	Varenr.	Antal Seg.	Segmentmål (l x h x b)	Kode
500	25,4	203901	36	40 x 10 x 4,0	TME1001
600	24,4	203902	42	40 x 10 x 4,5	TME1002
650	25,4	203903	45	40 x 10 x 4,5	TME1003
700	25,4	203904	49	40 x 10 x 4,5	TME1004
900	25,4	203905	60	40 x 10 x 4,5	TME1005
1000	25,4	203906	70	40 x 10 x 5,0	TME1006

MAKER TS-450 gulvsav med Honda GX390 Benzin 9,3KW

- Stål vandtank, 60 L
- Ø450 klinge *
- Skæredybde 165mm
- Manuel skæredybde justeres med det kraftige håndsving

TS450 er kompakt maskine, der er let at manøvrere
Den er perfekt til skærearbejde i meget små områder, med henblik på at skære kanaler for installation af rør, el- og telefonkabler i asfalt og beton overflader..



[BHL - Abrasive Beton Emerald Green]

- Abrasive beton, sandsten, betonfliser, mursten, schamotte
- Mixed asfalt / beton applications



Ø	Hul	Varenr.	Antal Seg.	Segmentmål (l x h x b)	Kode
300	25,4+T	200213	18	42 x 13 x 2,8	BHL1303
300	25,4+T	200214	20	42 x 13 x 2,8	BHL1304
350	25,4+T	200217	21	40 x 13 x 3,0	BHL1307
350	25,4+T	200218	24	40 x 13 x 3,0	BHL1308
400	25,4+T	200220	24	40 x 13 x 3,2	BHL1310

[JBT - Tile Cutter Grey]

- Keramik, tætte klinker, vitrificerede klinker, porcelæn, hård marmor
- Præcist snit



Ø	Hul	Varenr.	Segmentmål (h x b)	Kode
125	22,2	202703	6 x 1,6	JBT0003
150	22,2	202704	6 x 1,6	JBT0004
180	22,2	202705	6 x 1,6	JBT0005
200	30,0/25,4	202706	6 x 1,6	JBT0006
230	22,2	202707	6 x 1,6	JBT0007
250	30,0/25,4	202708	6 x 1,6	JBT0008
300	30,0/25,4	202709	7 x 2,0	JBT0009
350	30,0/25,4	202710	7 x 2,2	JBT0010

[JTC - Thin Turbo Tile Cutter]

- Keramik, tætte klinker, hård marmor, hårde vitrificerede produkter
- Intensiv skæring
- Ekstra tynd



Ø	Hul	Varenr.	Segmentmål (h x b)	Kode
125	22,2	202782	7 x 1,2	JTC4002
150	22,2	202783	7 x 1,6	JTC4003
180	22,2	202784	7 x 1,6	JTC4004
200	22,2	202785	7 x 1,6	JTC4005
230	22,2	202786	7 x 1,6	JTC4006
250	30/25,4	202787	7 x 1,6	JTC4007
300	30/25,4	202788	7 x 2,0	JTC4008
350	30/25,4	202789	7 x 2,2	JTC4009

[JCT - Tile Cutter Navy Blue]

- Terracotta, klinker, granit
- Præcist snit



Ø	Hul	Varenr.	Segmentmål (h x b)	Kode
125	22,2	202743	6 x 1,6	JCT0003
150	22,2	202744	6 x 1,6	JCT0004
180	22,2	202745	6 x 1,6	JCT0005
200	30,0/25,4	202746	6 x 1,6	JCT0006
230	22,2	202747	6 x 1,6	JCT0007
250	30,0/25,4	202748	6 x 1,6	JCT0008
305	30,0/25,4	202749	7 x 2,0	JCT0009
355	30,0/25,4	202750	7 x 2,2	JCT0010

[APS 13 - Black Intensive]

- Asfaltklinge (Abrasive materialer)
- Højt output, lang levetid
- "DEEP" segmenter beskytter stambladet



Ø	Hul	Varenr.	Antal Seg.	Segmentmål (l x h x b)	Kode
300	20	200601	18	42 x 13 x 2,8	APS1301
350	25,4+T	200606	21	40 x 13 x 3,0	APS1302
400	25,4+T	200609	24	40 x 13 x 3,2	APS1303

[VLA/BPH - Vega Abrasive]

- Asfalt, abrasivt beton (semi-abrasive materialer)
- Universalklinge til gulvarbejde



Ø	Hul	Varenr.	Segmentmål (l x h x b)
300	20	200692	38 x 10 x 3,2
300	25,4	200693	38 x 10 x 3,2
350	20	200695	38 x 10 x 3,2
350	25,4	200743	38 x 10 x 3,2
400	20	200698	38 x 10 x 3,5
400	25,4	200744	38 x 10 x 3,5
450	25,4	200745	

[INCISOR FS]

- TurboStart (Selvskærpnde segmenter)
- Intensiv skæring
- Granit, beton, byggematerialer, flint, armeret beton, metal-sektioner, jern, stål, wirenetforstærket beton
- Hurtigt snit
- Højt output, høj ydeevne

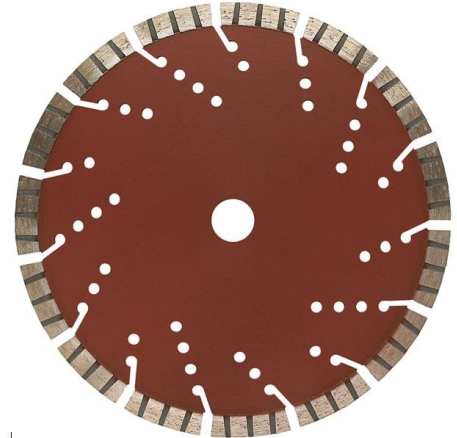

Ø	Hul	Varenr.	Segmentmål (l x h x b)
300	20	200335	
300	25,4	200336	
350	20	200337	
350	25,4	200338	
400	20	200339	
400	25,4	200340	

[BHL - Abrasive Concrete Emerald Green]

- Beton (abrasive aggregates)
- Mixed asfalt / beton opgaver
- Laser



Ø	Hul	Varenr.	Antal Seg.	Segmentmål (l x h x b)	Kode
300	20	200211	18	42 x 13 x 2,8	BHL1301
300	25,4+T	200213	18	42 x 13 x 2,8	BHL1303
300	20	200212	20	42 x 13 x 2,8	BHL1302
300	25,4+T	200214	20	42 x 13 x 2,8	BHL1304
350	20	200215	21	40 x 13 x 3,0	BHL1305
350	25,4+T	200217	21	40 x 13 x 3,0	BHL1307
350	20	200216	24	40 x 13 x 3,0	BHL1306
350	25,4+T	200218	24	40 x 13 x 3,0	BHL1308
400	20	200219	24	40 x 13 x 3,2	BHL1309
400	25,4+T	200220	24	40 x 13 x 3,2	BHL1310

[PANTERA] 

- Alle byggematerialer
- Intensiv skæring i granit
- Universalklinge

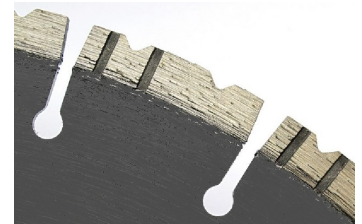
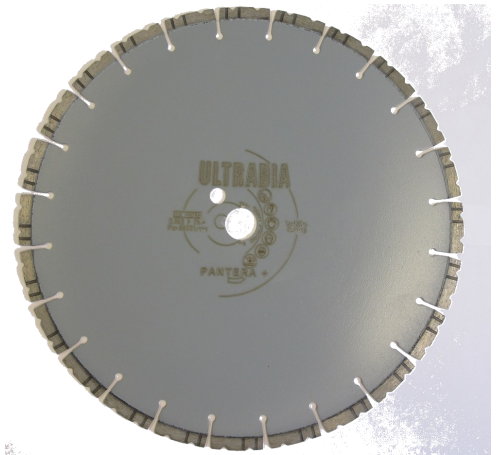

Ø	Hul	Varenr.	Antal Seg.	Segmentmål (l x h x b)	Kode
300	20	200016	20	38 x 10 x 2,8	PAP0003
300	25,4	200013	20	38 x 10 x 2,8	PAP0004
350	20	200017	24	38 x 10 x 3,2	PAP0005
350	25,4	200014	24	38 x 10 x 3,2	PAP0006
400	20	200018	28	38 x 10 x 3,2	PAP0007
400	25,4	200015	28	38 x 10 x 3,2	PAP0008

[Diaflex blå]



- Armeret beton, flint beton, lintels
- Semi-abrasive materials, washed concrete
- Universalklinge



Ø	Hul	Varenr.
350	25,4	200460
400	25,4	200470

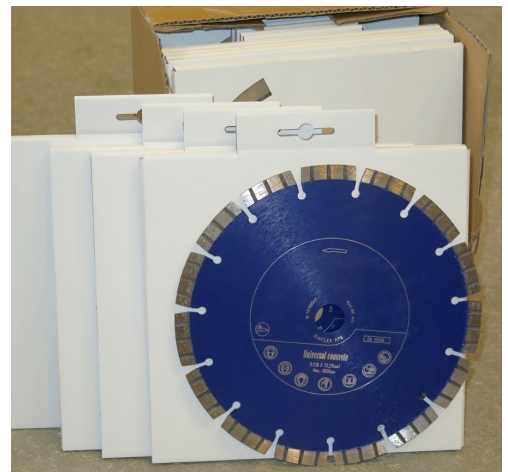

[AZE - High Performance Asphalt]

- TurboStart (Selv-skærpene segmenter)
- Asfaltklinge (Abrasive til semi-abrasive materialer)
- "DEEP"-segmenter beskytter stambladet



Ø	Varenr.	Antal Seg.	Segmentmål (l x h x b)	Kode	N ⁰ Prot.
500	201030	36	40 x 10 x 3,9	AZE1012	6
600	201031	42	40 x 10 x 3,9	AZE1001	6
600	201032	42	40 x 10 x 4,5	AZE1002	6
650	201033	46	40 x 10 x 3,9	AZE1003	6
650	201034	46	40 x 10 x 4,5	AZE1004	6
700	201035	50	40 x 10 x 4,5	AZE1005	6
750	201036	54	40 x 10 x 4,5	AZE1006	8
800	201037	57	40 x 10 x 4,5	AZE1007	8
900	201040	52	40 x 10 x 4,5	AZE1010	8
900	201038	64	40 x 10 x 4,5	AZE1008	8
1000	201041	58	40 x 10 x 4,5	AZE1011	8
1000	201039	70	40 x 10 x 4,5	AZE1009	10

Oplys centerhul og pin huller

[AHE - High Output Asphalt Black]

- TurboStart (Selv-skærpene segmenter)
- Asfaltklinge (Abrasive til semi-abrasive materialer)
- "DEEP"-segmenter beskytter stambladet



Ø	Varenr.	Antal Seg.	Segmentmål (l x h x b)	Kode	N ⁰ Prot.
600	201020	36	40 x 7,5 x 3,9	AHE0003	4
600	201023	36	40 x 7,5 x 4,5	AHE0004	4
650	201024	38	40 x 7,5 x 3,9	AHE0013	4
650	201026	38	40 x 7,5 x 4,5	AHE0014	4
700	201025	40	40 x 7,5 x 4,5	AHE0005	5
800	201027	46	40 x 7,5 x 4,5	AHE0006	6

[AHS - High Output Asphalt Black]

- TurboStart (Selv-skærpene segmenter)
- Asfaltklinge (Abrasive til semi-abrasive materialer)
- "DEEP"-segmenter beskytter stambladet



Ø	Varenr.	Hul	Antal Seg.	Segmentmål (l x h x b)	N ^o Prot.	Kode
300	201050	20	18	40 x 10 x 3,2	3	AHS0012
300	201052	25,4+T	18	40 x 10 x 3,2	3	AHS0002
350	201053	20	21	40 x 10 x 3,2	3	AHS0013
350	201054	25,4+T	21	40 x 10 x 3,2	3	AHS0004
400	201055	25,4+T	24	40 x 10 x 3,6	3	AHS0005
450	201057	25,4+T	26	40 x 10 x 3,6	4	AHS0007
500	201059	25,4+T	30	40 x 10 x 3,6	5	AHS0009

[APS 13 - Black Intensive]



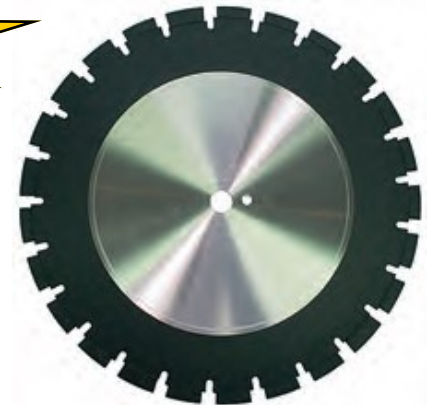

- Asfaltk (Abrasive aggregates)
- "DEEP"-segmenter beskytter stambladet





Ø	Varenr.	Hul	Antal Seg.	Segmentmål (l x h x b)	N ^o Prot.	Kode
350	200606	25,4+T	21	40 x 13 x 3,0	3	APS1302
400	200609	25,4+T	24	40 x 13 x 3,2	4	APS1303
450	200610	25,4+T	25	40 x 13 x 3,6	5	APS1304
500	200611	25,4+T	30	40 x 13 x 3,6	5	APS1305
600	200615	25,4+T	35	40 x 13 x 4,0	5	APS1306



Floor Saws

Varenr.	MAKER <small>S.r.l.</small>	BETON & ASFALT GULVSAVE	Kg.	Pris DKK.
		TS300 Plastik vandtank og manuel fremdrift Ø350 mm, skæredybde max 125 mm, 10L vandtank		
M010701		KOHLER CH270 Petrol Engine, 5,2 KW	59	
M010702		HONDA GX160 Petrol Engine, 4,0 KW	57	
M010703		1PHASE V230-50Hz Electric Engine, 2,2 KW	54	
<p>TS300 MAKER Gulvsav er enkel, let, robust og let at manøvrere og at transportere. Perfekt til skærearbejde i snævre rum. Håndtaget er justerbar og foldbart for at lette transport og manøvrering, selv for en enkel person. Skærings dybde kan indstilles i alle positioner ved håndsving. Vandtanken på 10 liter er aftagelig uden brug af værktøj. Front sværet er komplet med index for snit retning. Frem-stop sikkerhedsanordning, der standser bladets rotation.</p>				
		TS350 Plastik vandtank og manuel fremdrift Ø350 mm, Skæredybde max 125 mm, 30L vandtank		
M010102		KOHLER CH395 Petrol Engine, 7,1 KW	100	
M010104		HONDA GX270 Petrol Engine, 6,6 KW	98	
M010105		15LD350 LOMBARDINI Diesel Engine, 5,5 KW	100	
M010106		3PHASE V400-50Hz Electric Engine, 4,0 KW	92	
<p>TS350 MAKER Gulvsav er en kompakt maskine, der er let at manøvrere. Den er perfekt til skærearbejde i meget små områder, med henblik på at skære kanaler for installation af rør, el- og telefonkabler i asfalt og beton overflader. Takket være dens kompakte vægt, er den let at transportere, men stadig sikker og robust. Maskine er udstyret med god motorkraft som sikrer høj ydeevne. Manuel skæredybde justeres med håndsving. Komplet med plastic vandtank 30 liter for køling af diamantklinge. Muligheden for at et stort udvalg af motorer (benzin, elektrisk og diesel) for opfylde alle krav til skæring indenfor og udendørs.</p>				
		TS450 Plastik vandtank og manuel fremdrift Ø500mm, Skæredybde max 185 mm, 30L vandtank		
M8103A002		KOHLER CH440 Petrol Engine, 10,5 KW	112	
M010804		HONDA GX390 Petrol Engine, 9,6 KW	110	
M010805		ROBIN SUBARU EH41 Petrol Engine, 10,0 KW	110	
M010806		15LD440 AE LOMBARDINI Diesel Engine, 8,1 KW	122	
M010807		3PHASE V400-50Hz Electric Engine, 4,0 KW	96	
<p>TS450 MAKER Gulvsav er en kompakt maskine, der er let at manøvrere. Den er perfekt til skærearbejde i meget små områder, med henblik på at skære kanaler for installation af rør, el- og telefonkabler i asfalt og beton overflader. Takket være dens kompakte vægt, er den let at transportere, men stadig sikker og robust. Maskine er udstyret med god motorkraft som sikrer høj ydeevne. Manuel skæredybde justeres med håndsving. Komplet med plastic vandtank 30 liter for køling af diamantklinge. Muligheden for at et stort udvalg af motorer (benzin, elektrisk og diesel) for opfylde alle krav til skæring indenfor og udendørs.</p>				

Floor Saws

Varenr.	MAKER <small>S.A.L.</small>	BETON & ASFALT GULVSAVE	Kg.	Pris DKK.
		TS140 Stålvandtank og semiautomatisk fremdrift med håndsving. Ø500 mm, Skæredybde max 185 mm, 50L vandtank		
M8104A001		KOHLER CH440 Petrol Engine, 10,5 KW	167	
M010205		HONDA GX390 Petrol Engine, 9,6 KW	165	
M010206		ROBIN SUBARU EH41 Petrol Engine, 10,0 KW	161	
M010211		15LD440 AE LOMBARDINI Diesel Engine, 8,1 KW	186	
M010209		3PHASE V400-50Hz Electric Engine, 5,5 KW	151	
<p>TS140 Maker er fremstillet til skæring i asfalt og beton. Den er robust, kompakt og let at manøvrere. Særlig velegnet til skæreegaver i mindre og mellemstore overflader såsom beton industrigulve og asfalt vejarbejde. Manuel skæredybde justeres med håndsving. Komplet med stålvandtank 50 liter for køling af diamantklænge. Muligheden for at et stort udvalg af motorer (benzin, elektrisk og diesel) for opfylde alle krav til skæring indenfor og udendørs. TS140 kan leveres med hydraulik til manuel justering af skæredybde.</p>				
		TS160 Stålvandtank og semiautomatisk fremdrift med håndsving. Ø500mm, Skæredybde max 190 mm, 60L vandtank		
M010302		HONDA GX390 Petrol Engine 9,6 KW	204	
M010303		ROBIN SUBARU EH41 Petrol Engine, 10,0 KW	204	
M010309		15LD500 AE LOMBARDINI Diesel Engine, 8,8 KW	236	
M010308		3PHASE V400-50Hz Electric Engine, 7,5	214	
<p>TS160 MAKER Gulvsave er udviklet til skæring af industrigulve, skæring af dilatationsfuger og til reparation af enhver type af betonoverflader. Velegnet for virksomheder der udfører asfalkæring hvor det er nødvendigt med en høj ydeevne. Manuel skæredybde justeres med håndsving. 60 liter Stålvandtank med hermetisk låg og særlig antistøj og korrosionsbeskyttelse. Den elektriske version er med dobbelt isolering komplet med stik - stik og afbryder er med termisk Safe-Motor. TS160 kan leveres forberedt til Ø600 mm klinger / 25,4 mm med mulighed for en max. skæredybde på 240 mm.</p>				
		TS180 Stålvandtank og semiautomatisk fremdrift med håndsving. Ø600 mm, Skæredybde max 240 mm, 60L vandtank		
M010401		HONDA GX630 Petrol Engine (2 cylindere), 15,5 KW	255	
M010406		ROBIN SUBARU EH64 Petrol Engine (2 cylindere), 15,4 KW	255	
M010404		12LD477.2 AE LOMBARDINI Diesel Engine (2 cylindere) 17,0 KW	298	
M010405		3PHASE V400-50Hz Electric Engine, 9,2 KW	214	
<p>TS180 MAKER Gulvsave er udviklet til skæring af industrigulve og brolægge, der ønsker høj kraftoverførsel for at opnå en hurtig og præcis snit. Velegnet for virksomheder der udfører asfalkæring hvor det er store og mellemstore opgaver. Skæredybde justeres med manuel hydraulikpumpe. 60 liter Stålvandtank med hermetisk låg og særlig antistøj og korrosionsbeskyttelse. Et særligt femte hjul giver mulighed for hurtige ændringer. Den elektriske version er med dobbelt isolering komplet med stik - stik og afbryder er med termisk Safe-Motor.</p>				
M1601A098 M6310A006	TS160 og TS180 kan monteres med KIT for Automatisk fremdrift			

Floor Saws

Varenr.	MAKER <small>s.r.l.</small>	BETON & ASFALT GULVSAVE	Kg.	Pris DKK.
		TS200	Stål vandtank og automatisk fremdrift med Hydraulisk shifter Ø700 til 1000mm, Skæredybde max 270 mm, 80L vandtank	
M010501		Lambordini 9LD625.2 Diesel - Ø700mm 18,8kW / 25,6HP	534	Ring for pris
M010503		Lambordini 9LD625.2 Diesel - Ø900/1000mm 18,8kW / 25,6HP	570	Ring for pris
M010502		3PHASE 400V-50Hz - Ø700mm 15,0kW / 20,0HP	458	Ring for pris
1302A002		OPTION: Skærm for klinge Ø900 (H=370)		Ring for pris
		TS250	Stål vandtank og automatisk fremdrift med Hydraulisk shifter Ø1000mm, Skæredybde max 410 mm, 80L vandtank	
M010601		Lambordini 5LD825.2 A.E. Diesel - 25,0kW / 34,0HP	660	Ring for pris
M010602		3PHASE 400V-50Hz - Ø700mm 15,0kW / 20,0HP	630	Ring for pris
M010603		3PHASE 400V-50Hz - Ø700mm 22,0kW / 30,0HP	640	Ring for pris
1302A0145		OPTION: Skærm for klinge Ø1200 (H=500)		Ring for pris

[BVE - Alligator 22 HP]

- TurboStart (Selv-skærpene segmenter)
- Buer på siden af segmenterne
- Meget gammelt, tæt og armeret beton
- Meget hurtigt snit



Ø	Hul	Varenr.	Antal Seg.	Segmentmål (l x h x b)	Kode
450	25,4	204825	26	46 x 10 x 3,9	BVE0040
450	60,0	204826	26	46 x 10 x 3,9	BVE0040
500	25,4	204827	30	46 x 10 x 3,9	BVE0027
500	60,0	204828	30	46 x 10 x 3,9	BVE0027
600	25,4	204831	36	46 x 10 x 3,9	BVE0030
600	60,0	204832	36	46 x 10 x 3,9	BVE0030
650		204835	38	46 x 10 x 3,9	BVE0033
700	25,4	204871	40	46 x 10 x 3,9	BVE0054
700	60,0	204872	40	46 x 10 x 3,9	BVE0054
750		204875	42	46 x 10 x 4,2	BVE0048
800		204879	46	46 x 10 x 4,2	BVE0050
900		204853	52	46 x 10 x 4,2	BVE0051
1000		204883	58	46 x 10 x 4,2	BVE0052
1200		204886	68	46 x 10 x 4,2	BVE0053

Oplys centerhul og pin huller

SUNDT GS675 gulvsav

- 7,5kW
- 400V
- Ø600
- Skæredybde 250mm
- 112 kg



Sundt 675 gulvsav er en robust klassisk gulvsavsmaskine med mange års succesfuld drift under de hårdeste forhold. Gulvsaven er den perfekte løsning til mindre arbejdsopgaver og et begrænset budget, men uden at gå på kompromis med kvaliteten. **Gulvsaven er smart modulær** Gulvsaven har en veldesignet modulstruktur, som giver den højest mulige mobilitet. Du kan skifte mellem venstre og højre kryds. Gulvsaven har en trinløs cutter indstilling.

[BTL - High Performance Concrete]

- Armeret beton, self-locking cobbelstones, washed flint tiles



Ø	Hul	Varenr.	Antal Seg.	Segmentmål (l x h x b)	Kode
350	25,4+T	201906	21	40 x 13 x 3,0	BTL1304
400	25,4+T	201909	24	40 x 13 x 3,2	BTL1306
450	25,4+T	201911	25	40 x 13 x 3,6	BTL1307
500	25,4+T	201913	30	40 x 13 x 3,6	BTL1308
600	25,4+T	201915	34	40 x 13 x 3,6	BTL1309
700	25,4+T	201917	40	40 x 13 x 3,6	BTL1310
750	25,4+T	201919	42	40 x 13 x 3,6	BTL1311
800	25,4+T	201921	46	40 x 13 x 3,6	BTL1312
900	25,4+T	201923	56	40 x 13 x 3,6	BTL1313

SUNDT GS800 gulvsav

- 7.5kW
- 400V
- Ø800
- Skæredybde 320mm
- 185 kg



[ABR - Grooving]

- Rillefræsning af abrasivt beton og asfalt (kabel lægning).
mørtel rivning af beton gulve
- Brede mellemrum mellem segmenterne giver højt output
- Kabel lægning
- Kan leveres i flere bredder



Ø	Hul	Varenr.	Antal Seg.	Segmentmål (l x h x b)	Kode
300	25,4	200351	18	40 x 6 x 6	ABR0001
300	25,4	200353	18	40 x 6 x 8	ABR0003
300	25,4	200354	18	40 x 6 x 10	ABR0004
300	25,4	200355	18	40 x 6 x 12	ABR0005
300	25,4	200356	18	40 x 6 x 15	ABR0006
350	25,4	200357	21	40 x 6 x 6	ABR0007
350	25,4	200359	21	40 x 6 x 8	ABR0009
350	25,4	200360	21	40 x 6 x 10	ABR0010
350	25,4	200361	21	40 x 6 x 12	ABR0011
350	25,4	200362	21	40 x 6 x 15	ABR0012
400	25,4	200363	24	40 x 6 x 6	ABR0013
400	25,4	200365	24	40 x 6 x 8	ABR0015
400	25,4	200366	24	40 x 6 x 10	ABR0016
400	25,4	200367	24	40 x 6 x 12	ABR0017
400	25,4	200368	24	40 x 6 x 15	ABR0018
450	25,4	200369	26	40 x 6 x 6	ABR0019
450	25,4	200370	26	40 x 6 x 8	ABR0020
450	25,4	200371	26	40 x 6 x 10	ABR0021
450	25,4	200372	26	40 x 6 x 12	ABR0022
450	25,4	200373	26	40 x 6 x 15	ABR0023
500	25,4	200374	30	40 x 6 x 6	ABR0024
500	25,4	200375	30	40 x 6 x 8	ABR0025
500	25,4	200376	30	40 x 6 x 10	ABR0026
500	25,4	200377	30	40 x 6 x 12	ABR0027
500	25,4	200378	30	40 x 6 x 15	ABR0028

[BBR - Grooving]

- Rillefræsning af beton
- Brede mellemrum mellem segmenterne giver højt output
- Kabellægning m.m.
- Kan leveres i flere bredder.

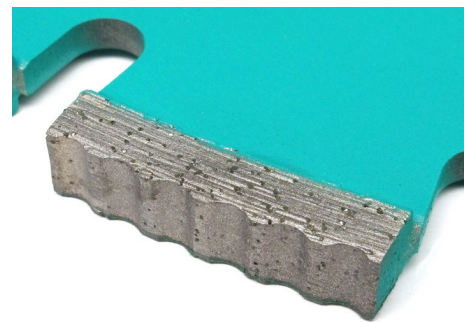

Ø	Hul	Varenr.	Antal Seg.	Segmentmål (l x h x b)	Kode
300	25,4	204601	18	40 x 6 x 6	BBR0001
300	25,4	204603	18	40 x 6 x 8	BBR0003
300	25,4	204604	18	40 x 6 x 10	BBR0004
300	25,4	204605	18	40 x 6 x 12	BBR0005
300	25,4	204606	18	40 x 6 x 15	BBR0006
350	25,4	204607	21	40 x 6 x 6	BBR0007
350	25,4	204609	21	40 x 6 x 8	BBR0009
350	25,4	204610	21	40 x 6 x 10	BBR0010
350	25,4	204611	21	40 x 6 x 12	BBR0011
350	25,4	204612	21	40 x 6 x 15	BBR0012
400	25,4	204613	24	40 x 6 x 6	BBR0013
400	25,4	204615	24	40 x 6 x 8	BBR0015
400	25,4	204616	24	40 x 6 x 10	BBR0016
400	25,4	204617	24	40 x 6 x 12	BBR0017
400	25,4	204618	24	40 x 6 x 15	BBR0018
450	25,4	204619	26	40 x 6 x 6	BBR0019
450	25,4	204620	26	40 x 6 x 8	BBR0020
450	25,4	204621	26	40 x 6 x 10	BBR0021
450	25,4	204622	26	40 x 6 x 12	BBR0022
450	25,4	204623	26	40 x 6 x 15	BBR0023
500	25,4	204624	30	40 x 6 x 6	BBR0024
500	25,4	204625	30	40 x 6 x 8	BBR0025
500	25,4	204626	30	40 x 6 x 10	BBR0026
500	25,4	204627	30	40 x 6 x 12	BBR0027
500	25,4	204628	30	40 x 6 x 15	BBR0028

[BIA - Abrasive Orange] **"NY BETON"**

- Skæring grøn industri beton 6h—24h
- Abrasive beton (polypropylen fibre, abrasive aggregates, høj koncentration af jern)
- Vertical segmenter for beskyttelse af stambladet



∅	Hul	Varenr.	Antal Seg.	Segmentmål (l x h x b)	N ⁰ Prot	Kode
300	25,4	204203	21	40 x 10 x 2,8	3	BIA1003
350	25,4	204204	24	40 x 10 x 2,8	3	BIA1004
400	25,4	204205	28	40 x 10 x 2,8	4	BIA1005

[BIB - Compact Grey] **"NY BETON"**

- Skæring grøn industri beton 6h—24h
- Universal, compact to semi-Abrasive beton (hard aggregates, polypropylen fibre, høj koncentration af jern)
- Vertical segmenter for beskyttelse af stambladet



∅	Hul	Varenr.	Antal Seg.	Segmentmål (l x h x b)	N ⁰ Prot	Kode
300	25,4	204301	20	40 x 9 x 2,8	3	BIB1001
350	25,4	204302	24	40 x 9 x 2,8	3	BIB1002
400	25,4	204303	28	40 x 9 x 2,8	4	BIB1003
450	25,4	204304	32	40 x 9 x 3,6	4	BIB1004

[BIC - Compact Emerald] **"NY BETON"**

- Skæring grøn industri beton 6h—24h
- Kompakt beton (hard aggregates, polypropylen fibre, høj koncentration af jern)
- Vertical segmenter for beskyttelse af stambladet



∅	Hul	Varenr.	Antal Seg.	Segmentmål (l x h x b)	N ⁰ Prot	Kode
300	25,4	204501	21	40 x 10 x 2,4	3	BIC1001
300	25,4	204502	21	40 x 10 x 2,8	3	BIC1002
350	25,4	204503	24	40 x 10 x 2,8	3	BIC1003

[GOLD Klinger] 

- Armeret beton
- Beton m/ flint
- Gammelt beton
- Europæisk fremstillet

Valg af klinger bestemmes sædvanligvis af maskintype, KW, betontype, armering, flint, RPM etc.

Diaflex lagerfører klinger ud fra markedets efterspørgsel. Typisk vælges klingerne for mindre maskiner i Gold15, for kraftige maskiner, hvor der ønskes længere levetid, vælges typisk Gold17 eller Gold20.

Goldklingerne er kun et udpluk ad Diaflex' program af klinger.

Kontakt endelig én af vores sælgere for yderligere valgmuligheder.

Ø	GOLD 15 <15kW	GOLD 17 15 til 20kW	GOLD 20 20 til 30kW
600	3,8		
600	4,4		
600	4,7		
600	5,0		
700	4,0		
700	4,4		
700	4,7		
700	5,0		
800	4,4		
800	4,7		
800	5,0		
900	4,4		
900	4,7		
900	5,0		
1000	4,4		
1000	4,7		
1000	5,0		
1200	4,4		
1200	4,7		
1200	5,0		
1400	4,4		
1400	4,7		
1400	5,0		
1500	4,4		
1500	4,7		
1500	5,0		
1600	4,4		
1600	4,7		
1600	5,0		

Ring for pris

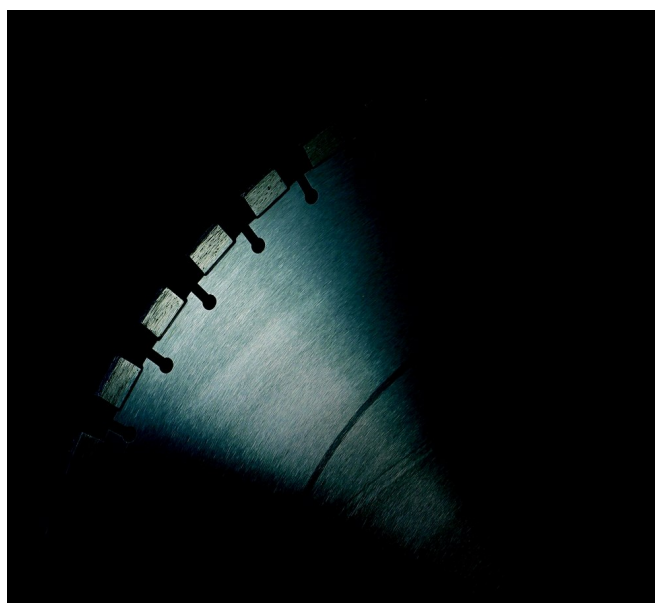
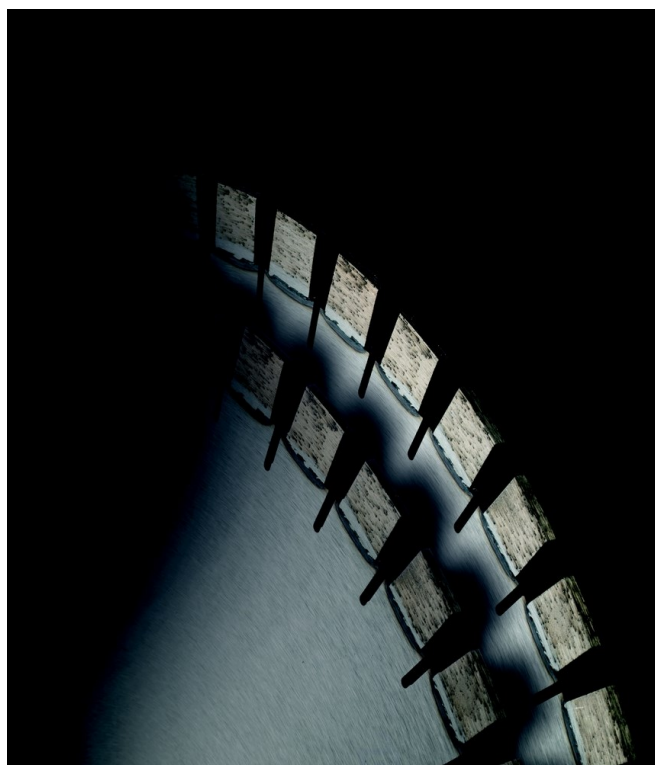

[CPH Klinger]

- Armeret beton
- Beton m/ flint
- Gammelt beton
- Europæisk fremstillet

Ø	
600	3,8
600	4,4
600	4,7
600	5,0
700	4,0
700	4,4
700	4,7
700	5,0
800	4,4
800	4,7
800	5,0
900	4,4
900	4,7
900	5,0
1000	4,4
1000	4,7
1000	5,0
1200	4,4
1200	4,7
1200	5,0
1400	4,4
1400	4,7
1400	5,0
1500	4,4
1500	4,7
1500	5,0
1600	4,4
1600	4,7
1600	5,0

Ring for pris

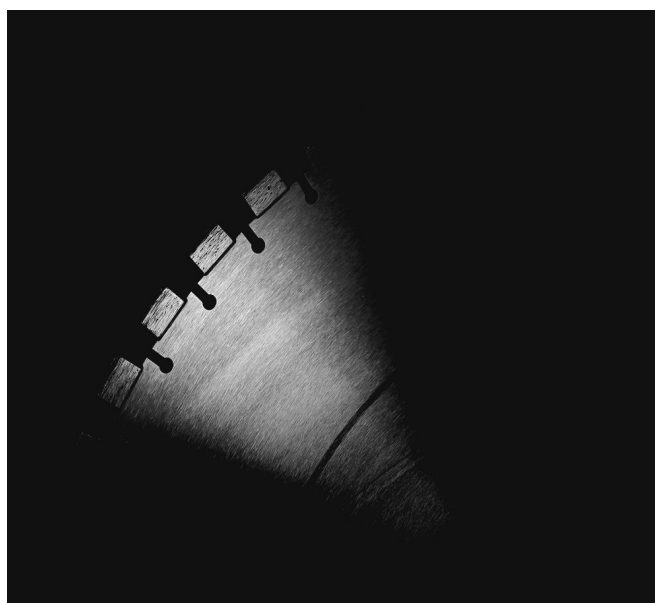
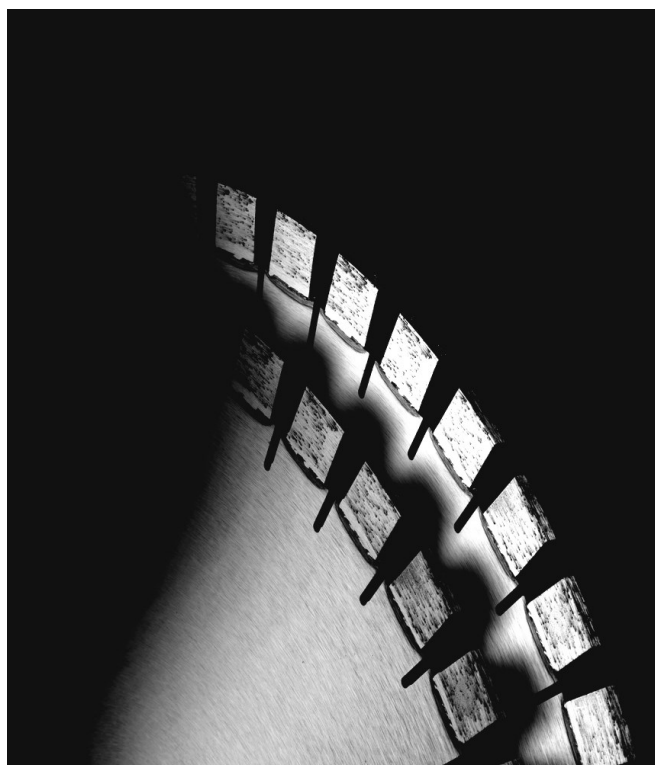

Diaflex Betonsliber

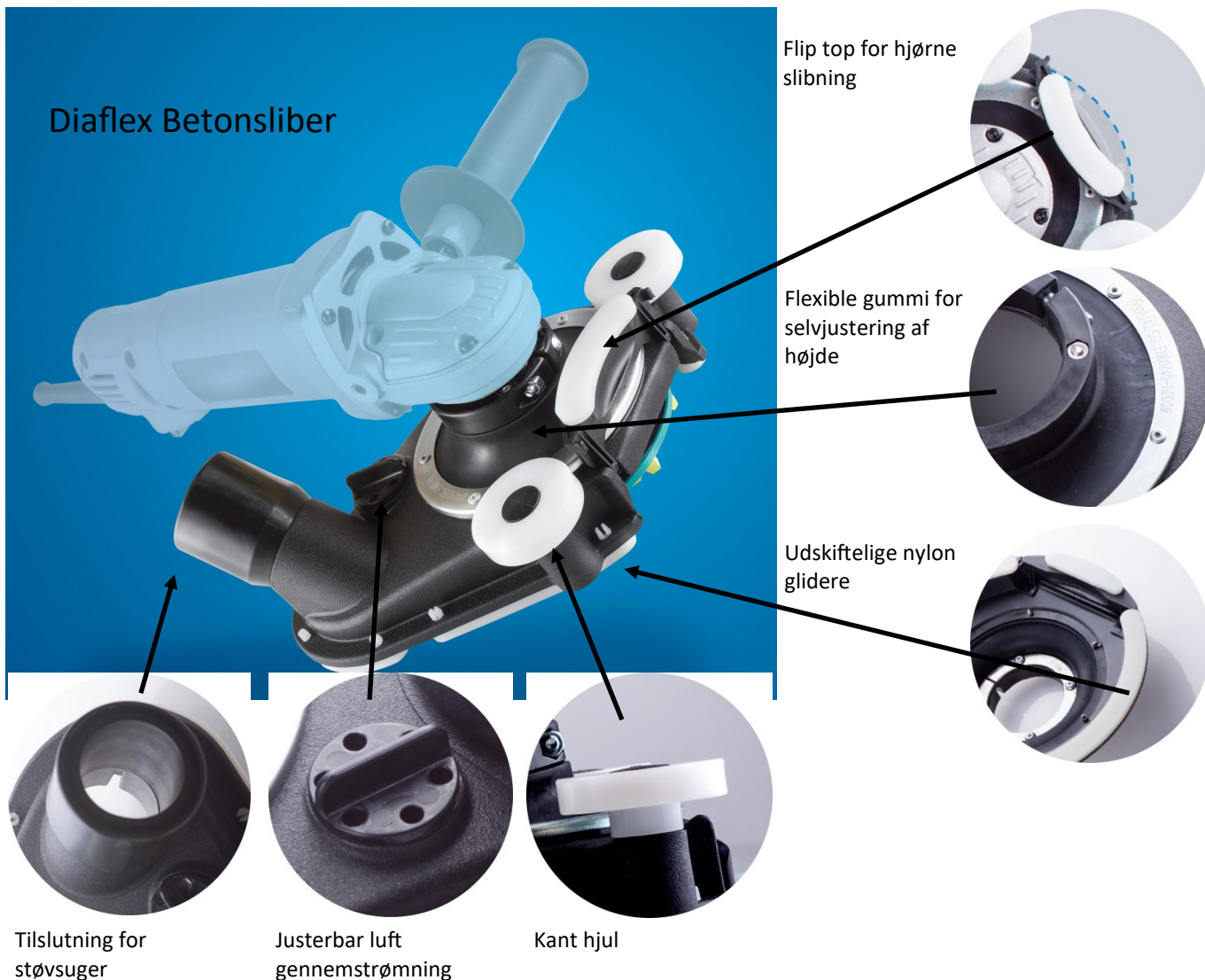

[RAS - SUPER RAPTOR]



- Skrabning og overfladebehandling af beton.
- Velegnet til fliselim og epoxy.
- Stor kontaktflade til arbejde i blødt beton
- Lang levetid



Patented

Ø	Hul	Varenr.	Antal Seg.	Segmentmål (l x h x b)	Kode
125	22,2	201425	8	17 x 5 x 8,0	RAS125.01
150	19,0	201427	10	17 x 5 x 8,0	RAS150.01
180	22,2	201428	12	17 x 5 x 8,0	RAS180.01

[RAP - RAPTOR] 

- Skrabning og overfladebehandling af beton.
- Velegnet til fliselim og epoxy.
- Stor kontaktflade til arbejde i blødt beton
- Ekstra lang levetid

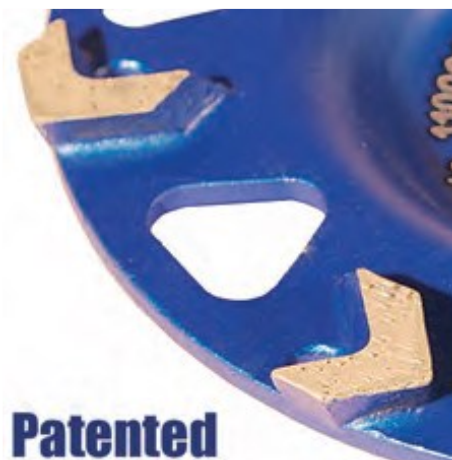
**Patented**

Ø	Hul	Varenr.	Antal Seg.	Segmentmål (l x h x b)	Kode
125	22,2	201420	8	17 x 5 x 5,5	RAP125.01
150	19,0	201422	10	17 x 5 x 5,5	RAP150.01
180	22,2	201421	12	17 x 5 x 5,5	RAP180.01

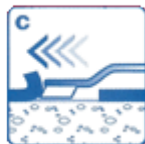

- Fjerner selv de hårdeste adhesive belægninger.
- Raptor er specielt udviklet til fjernelse af epoxy samt gummibelægninger, men kan også bruges til mange andre materialer.
- Med Raptoren er det muligt at holde en meget høj arbejdshastighed, samt at holde prisen pr. sleben kvadratmeter nede.
- De patenterede tænder på Raptoren gør at diamantsegmenterne kommer ind under belægningen og rykker derfor store stykker af materialet af.

[SKR - SCRAPPER PCD] 

- Fjernelse af klæbende belægninger på betonoverflader (Epoxy coatings, spartelmasse, tjære, gips, limrester)
- Fjernelse af asbest

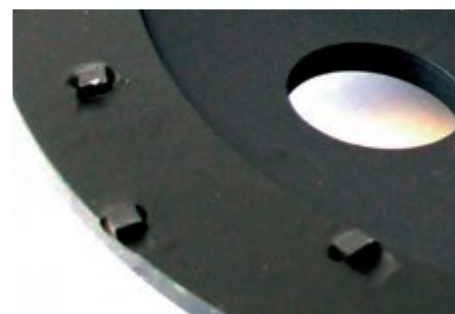

Ø	Varenr.	Antal Seg.	Kode
125	201438	12	SKR125.01
175	201439	24	SKR175.01

[BOC - BOOMY GUL] 

- TurboStart (Selvskærpande segmenter)
- Beton, cement (Grov slibning)
- Højt output

**Patented**

Ø	Hul	Varenr.	Antal Seg.	Segmentmål (l x h x b)	Kode
100	M14*	201402	5	40 x 5 x 8,0	BO100C.05
100	22,2	201403	5	40 x 5 x 8,0	BO100C.04
125	22,2	201404	8	40 x 5 x 8,0	BO125C.02
150	19,0	201400	10	40 x 5 x 8,0	BO150C.02
180	22,2	201405	10	40 x 5 x 8,0	BO180C.03

*M14 gevindet passer på de fleste vinkelslibere.

[BOG - BOOMY GRØN] 

- TurboStart (Selvskærpande segmenter)
- Granit, beton, terazzo, kalksten, cement (Fin slibning)
- Højt output, lang levetid

**Patented**

Ø	Hul	Varenr.	Antal Seg.	Segmentmål (l x h x b)	Kode
100	M14*	201414	5	40 x 5 x 8,0	BO100G.05
100	22,2	201413	5	40 x 5 x 8,0	BO100G.04
125	22,2	201416	8	40 x 5 x 8,0	BO125G.02
150	19,0	201401	10	40 x 5 x 8,0	BO150G.02
180	22,2	201417	10	40 x 5 x 8,0	BO180G.03

M14 gevindet passer på de fleste vinkelslibere.

[BOF - BOOMY GRÅ]

- Granit, marmor
- Finish

Ø	Hul	Varenr.	Antal Seg.	Segmentmål (l x h x b)	Kode
125	22,2	201410	7	50 x 16 x 5,5	BO125F.01
150	19,0	201411	8	50 x 16 x 5,5	BO150F.01
180	22,2	201412			

M14 gevindet passer på de fleste vinkelslibere.



[BUTTERFLY]

- TurboStart (Selvskærpende segmenter)
- Beton, cement (Grov slibning)
- Højt output

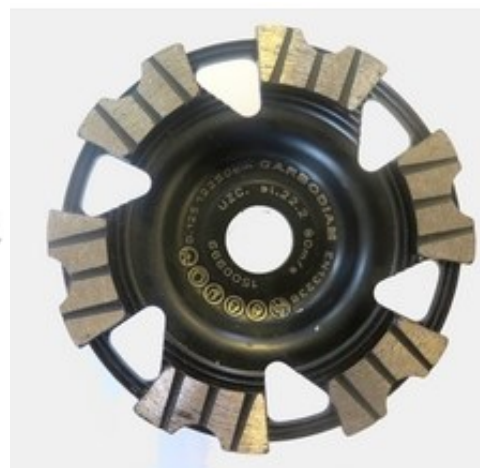

Ø	Hul	Varenr.	Antal Seg.	Segmentmål (l x h x b)	Kode
125	22,2	201460			
130	22,2	201461			
150	19,0	201462			
180	22,2	201463			



MITO551 Professional Floor Grinding Machine with Planetary Head

Mito 551: med 550 mm arbejdsområde for små til mellemstore flader.

Hovedtræk:

- Arbejdsbredde 550 mm, 3 stk. 200 mm værktøj.
- Hastighed af værktøjer spænder fra 400 til 1300 rpm.
- Stærk gearkasse med termo-hærdet stålgear for et længere liv.
- Ingen støj under arbejdet.
- Autoudjævnende planetarisk system.
- Kraftig HP motor 4 eller 5,5
- 46L. Vandbeholder



Counter Rotating System



Optional

Removable Planetary Head for easy transport

DCS SYSTEM

ESTIMATED PRODUCTION RATES

SUPERCONCRETE 7 step	8-12 m ² / h
Concrete Grinding 1 step	35-70 m ² / h
Terrazzo Polishing 5 step	8-12 m ² / h
Resin Removing 1 step	35-70 m ² / h
Varnish Removing 1 step	35-70 m ² / h
Marble Polishing 5 step	6-10 m ² / h
Granite Polishing 7 step	5-6 m ² / h

TECHNICAL DATA

Model	Motor	Drive Inverter	Volt	Hertz	Amp	Speed tools rpm	Dimensions WxHxD cm	Weight	Pris Dkr
Mito 551	2900 Watt max	—	220	50	—	800	120x125x57	135 kg	Ring for pris
Mito 551 VS	3000 Watt max	4kw mono	220	50/60	—	400-1000	120x125x57	140 kg	Ring for pris
Mito 551 TS	5,5 HP	—	380-480	50/60	16	800	120x125x57	150 kg	Ring for pris
Mito 551 TS VS	5,5 HP	4kw 3ph	380-480	50/60	16	600-1000	120x125x57	160 kg	Ring for pris



Ergonomic control Panel for easy use

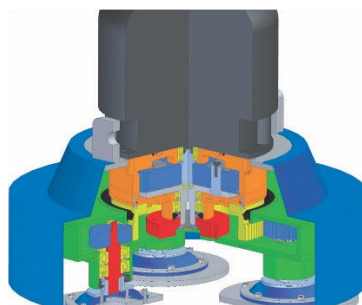

Tempered steel gear box for long lasting



Planetary system with big working width 550mm

MITO451

 Floor Grinding Machine with “DCS System” and variable speed

Mito serien introducerer det innovative DCS-system, der giver i én enkelt maskine funktionerne af to. • Funktionen Hercules bruger modsat roterende satellitter slibning og polering af beton, marmor og natursten gulve. • Det kraftfulde DCS-system øger satellitternes rotationshastighed, Mito står for højtydende industrielle maskiner til gulvforberedelse. Velegnet til hurtig fjernelse af harpiks og lim, til hurtig afmontering af aggregaterne og til hurtig udjævning af meget ujævne overflader.

- Hovedtræk:**
- Arbejdsbredde 450 mm, 3 stk 200 mm værktøj.
 - Hastighed af værktøjer spænder fra 400 til 1000 rpm.
 - Stærk gearkasse med termo-hærdet stålgear for et længere liv.
 - Ingen støj under arbejdet. • Autoudjævrende planetarisk system.
 - Umiskendelig italiensk design.



DCS SYSTEM



ESTIMATED PRODUCTION RATES

SUPERCONCRETE 7 step	7-10 m ² / h
Concrete Grinding 1 step	30-35 m ² / h
Terrazzo Polishing 5 step	6-9 m ² / h
Resin Removing 1 step	30-60 m ² / h
Varnish Removing 1 step	30-60 m ² / h
Marble Polishing 5 step	5-8 m ² / h
Granite Polishing 7 step	4-6 m ² / h



Counter Rotating System



Optional

TECHNICAL DATA

Model	Motor	Drive Inverter	Volt	Hertz	Amp	Speed tools rpm	Dimensions WxHxD cm	Weight	Pris Dkr
Mito 451	2900	—	220	50	—	800	120x125x47	130 kg	Ring for pris
Mito 451 VS	3000	4kw	220	50/60	—	800-1000	120x125x47	135 kg	Ring for pris

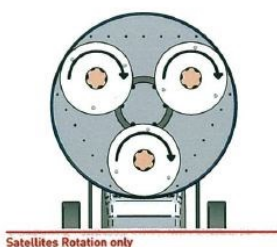

Satellites Rotation only

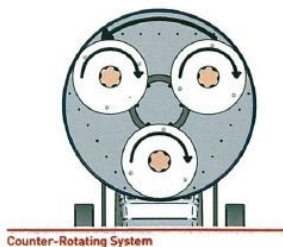

Counter-Rotating System



Full Metal Gear Box

MITO450

Floor Grinding Machine with "DCS System" and variable speed



DCS SYSTEM

Op til 50kg.
ekstra vægt



- Hovedtræk:**
- Arbejdsbredde 450 mm, 3 stk 200 mm værktøj.
 - Hastighed af værktøjer spænder fra 400 til 1000 rpm.
 - Stærk gearkasse med termo-hærdet stålgear for et længere liv.
 - Ingen støj under arbejdet.
 - Autoudjævnende planetarisk system.
 - Umiskendelig italiensk design.

ESTIMATED PRODUCTION RATES

Task	Estimated Production Rate
SUPERCONCRETE 7 step	7-10 m ² / h
Concrete Grinding 1 step	30-35 m ² / h
Terrazzo Polishing 5 step	6-9 m ² / h
Resin Removing 1 step	30-60 m ² / h
Varnish Removing 1 step	30-60 m ² / h
Marble Polishing 5 step	5-8 m ² / h
Granite Polishing 7 step	4-6 m ² / h

TECHNICAL DATA

Model	Motor	Drive Inverter	Volt	Hertz	Amp	Speed tools rpm	Dimensions WxHxD cm	Weight	Pris Dkr
Mito 450	2900	—	220	50	—	800	120x125x47	135 kg	Ring for pris
Mito 450 VS	3000	4kw	220	50/60	—	800-1000	120x125x47	135 kg	Ring for pris

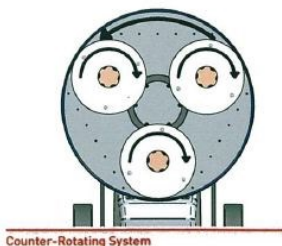
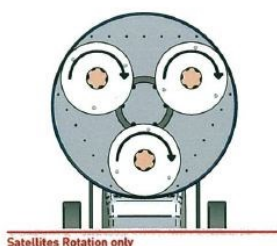

DIAMANTVÆRKTØJ TIL MITO

DD series Diamantværktøj til hårdt beton.

401527	DD00 Grit 20 - 4 segmenter	Ø200
401521	DD0 Grit 40 - 4 segmenter	Ø200
401550	DD1 Grit 70 - 4 segmenter	Ø200
401551	DD2 Grit 140 - 4 segmenter	Ø200



DA series Diamantværktøj til medium-hårdt beton.
(Brug ikke på abrasive beton).

401575	DA00 Grit 20 - 6 segmenter	Ø200
401576	DA0 Grit 40 - 6 segmenter	Ø200
401577	DA1 Grit 70 - 6 segmenter	Ø200
401578	DA2 Grit 140 - 6 segmenter	Ø200
401546	DA00 Grit 20 - 6 segmenter	Ø240
401547	DA0 Grit 40 - 6 segmenter	Ø240
401548	DA1 Grit 70 - 6 segmenter	Ø240
401549	DA2 Grit 140 - 6 segmenter	Ø240

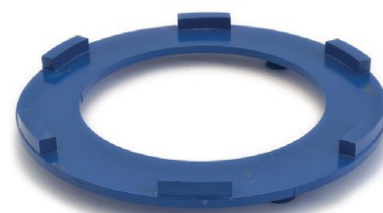

CA series Diamantværktøj til abrasive beton

401573	CA00 Grit 20 - 6 segmenter	Ø200
401522	CA0 Grit 40 - 6 segmenter	Ø200
401555	CA1 Grit 70 - 6 segmenter	Ø200
401572	CA2 Grit 140 - 6 segmenter	Ø200
401540	CA00 Grit 20 - 6 segmenter	Ø240
401541	CA0 Grit 40 - 6 segmenter	Ø240
401542	CA1 Grit 70 - 6 segmenter	Ø240
401543	CA2 Grit 140 - 6 segmenter	Ø240

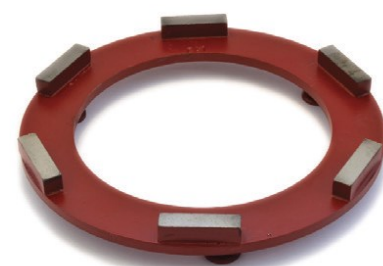

Beton Hardener - Beton Guard Lithium

401554	Beton Hardener Lithium	5L
401555	Beton Hardener Lithium	25L
401515	Beton Guard Lithium	5L
401524	Beton Guard Lithium	25L



TERMINATOR240



Samich har designet et komplet udvalg af betonslibere og diamantprodukter, som giver mulighed for at håndtere alle gulve og specifikt formål.

Terminator 240 er en enkelt-disc betonsliber specielt designet til små og mellemstor vandret overfladeforberedelse, det gør det muligt at slibe ca. 200-250 sq. ft. per time.

Terminator 240 er meget let og behagelig at bruge pga. dens lave vibrationer. Terminatoren 240 enkelt disk slibemaskine er støvfri når den er tilsluttet til det relevante DUSTNATOR støvindsamlingsystem. Perfekt maskine til overfladebehandling af små til mellemstore gulve, overfladeudjævning, betonforberedelse før coating, fjernelse af coating defekter eller klister, fjernelse tætningsmaterialer, thin-sets, malingsophobninger, harpiks og mere, reparere beskadigede betonplader, udjævning af ru overflader, regn mærker eller murske mærker.

Hovedtræk: • Massiv stålkrop • Kraftfuld motor med høj effekt

- Støvfri, når den er tilsluttet en passende Dustnator støvsamler
- Vakuumport og vandtank til rådighed
- Kan slibe helt op til kanten takket være dets specielle design
- Single-head slibemaskine Ø 240 mm med hurtig samlingssystem
- Justerbar slibe dybde • Brugervenlig og behagelig at bruge pga. lave vibrationer
- Kompakt og let: let at transportere og bære ovenpå.



ESTIMATED PRODUCTION RATES

Concrete Grid 1 step	20-25 m ² / h
Terrazzo Grid 1 step	45-75 m ² / h
Resin Removing 1 step	15-25 m ² / h
Varnish Removing 1 step	15-30 m ² / h

TECHNICAL DATA

Model	Motor	Volt	Hertz	Amp	Speed tools rpm	Dimensions WxHxD cm	Weight	Pris Dkr
Terminator 240	2900	230	50	—	1400	70x110x25	53 kg	Ring for pris
Terminator 240 VS	3000	230	50/60	—	800-2000	70x110x25	53 kg	Ring for pris

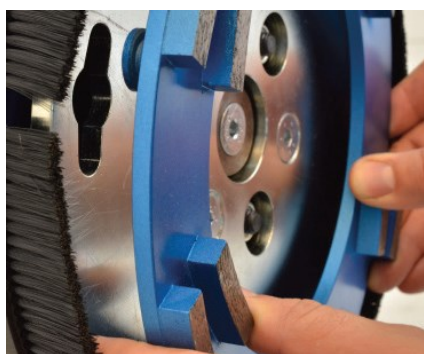

Floating Disc 240mm



Lateral inlet
Ideel til at arbejde på det samme niveau indtil væggen

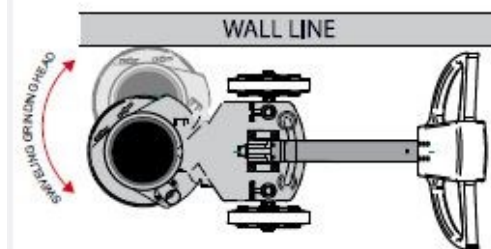

Swiveling grinding head
Mulighed for at arbejde helt ind til væggen

DIAMANTVÆRKTØJ TIL TERMINATOR 240

TCK series Diamantværktøj med TCK teknologi til betongulve.

401621	TCK00S Grit 12 - 12 segmenter	Ø240
401622	TCK00 Grit 20 - 12 segmenter	Ø240
401623	TCK0 Grit 40 - 12 segmenter	Ø240

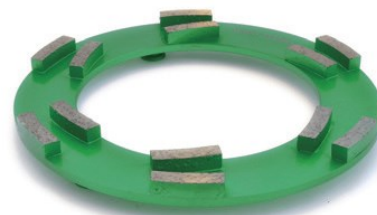

DA series Diamantværktøj til medium-hårdt beton.
(Brug ikke på abrasive beton).

401625	DA00 Grit 20 - 12 segmenter	Ø240
401626	DA0 Grit 40 - 12 segmenter	Ø240
401627	DA1 Grit 70 - 12 segmenter	Ø240
401628	DA2 Grit 140 - 12 segmenter	Ø240

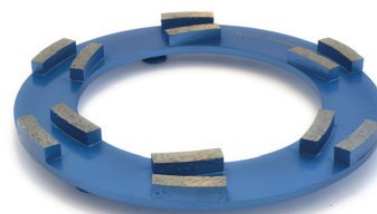

VERTICAL LEGEND

LEGEND Super Hand Grinder



Legend Super Hand Grinder er den ideelle maskine til at opnå en perfekt polering af køkkenbordet, hylder, borde og andre smalle områder.

Den kan bruges som en Beton- eller marmorkant slibemaskine, samt en trappe bush-hammer og som en samlings 'Chaser' takket være dens ekstra tilbehør.

Hovedtræk:

- Det er eneste håndsliber med IP54 beskyttelse i verden.
- Enestående asynkron motorstyrke, i forhold til en traditionelle motorer holder den længere takket være at den er beskyttet mod ydre påvirkninger som vand eller støv.
- Store gear og lejer i forhold til traditionelle håndslibere.
- Mulighed for at understøtte den med en bagvedliggende kugleformede hjul vogn for at opnå en perfekt flad overflade (for at undgå bølgeeffekten).
 - Front LED lys for at oplyse arbejdsområdet.
 - Roterende-hoved-funktion.
 - Hastighedskontakt for slibning / polering.
 - Udførelse af våd eller tør slibning (udstyret med en vand dyse).



Legend Super Hand Grinder Top omfatter: Kugleformede baghjul med uafhængig tilpasning, beskyttende sugehætte 125mm, stænkskærm 125mm, blød platorello 125mm, justerbart hoved med kugleformet guide.

Legend Super Hand Grinder Top VS omfatter: Kugleformede baghjul med uafhængig tilpasning beskyttende sugehætte 125mm, stænkskærm 125mm, blød platorello 125mm, justerbart hoved med kugleformet guide, variabel hastighed.

LED-lys og andet tilbehør er valgfri.



Håndsliber med justerbart hoved, for hjørner, kanter, bordplader, fodpaneler, trapper, for bush-hammer trapper og små flader og åbne samlinger.

TECHNICAL DATA

Model	Motor	Tools	Tools	Dimensions WxHxD cm	Weight	Pris Dkr
Legend Super Hand Grinder	750W	125/150mm	125/150mm	45x33x23	10 kg	Ring for pris
219003 Legend Super Hand Grinder VS	750W	125/150mm	125/150mm	45x33x23	10 kg	Ring for pris



For professional grinding



Grinding and polishing perimeters and edges.



Wet and Dry grinding operation.

VÆRKTØJ TIL LEGEND Super Hand Grinder

Jaguar Flex Ø125mm

401531	Jaguar flex grit 30 - Grøn	Ø125
401532	Jaguar flex grit 60 - M. Grøn	Ø125
401533	Jaguar flex grit 120 - Sort	Ø125
401534	Jaguar flex grit 220 - Rød	Ø125
401535	Jaguar flex grit 400 - Gul	Ø125
401536	Jaguar flex grit 800 - Hvid	Ø125
401537	Jaguar flex grit 1500 - Blå	Ø125
401538	Jaguar flex grit 3500 - Grå	Ø125



Tools Holder Kit

Sættet indeholder Vakuum Skærm, Velcro tool holder og stink-skærm

SR45047	Tool holder Kit	Ø125
SR45049	Tool holder Kit	Ø150



LEGEND COUNTER TOP



Legend Counter Top er en INNOVATION AWARD WINNING maskine, der er perfekt afbalanceret og nem at bruge på trapper, bordplader og svært tilgængelige steder. Det har et modsat roterende planetarisk system, der gør det muligt for dig at slibe, skærpe og polere alle overflader. Den er konstrueret og bygget med høj præcision hvilket gør den stabil og praktisk anvendelig. Legend C.T. har meget tilbehør, som tillader dig at omdanne den til en mindre gulvslibemaskine til små opgaver. Den kan også anvendes til overfladebehandling af træ

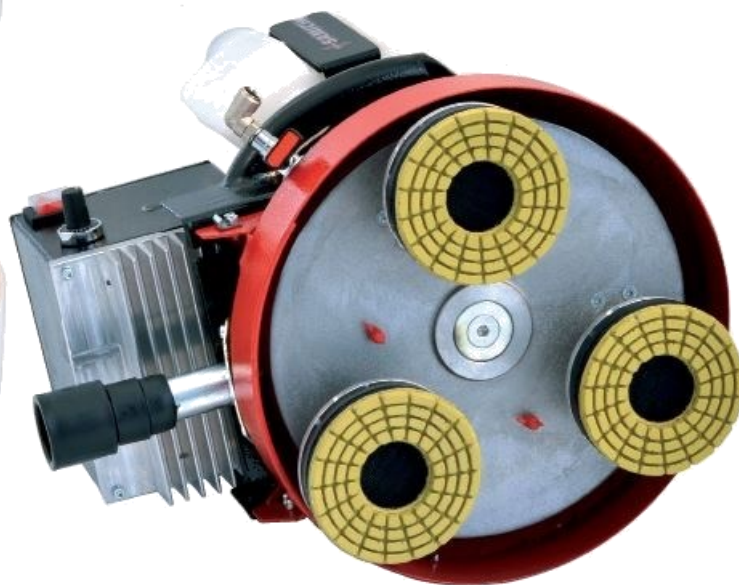

Counter Rotating System

TECHNICAL DATA

	Model	Motor	Tool Size	Working Widht	Speed Tools rpm	Dimensions WxHxD cm	Weight
219007	Counter Top 290	750W	3x100mm	290mm	1000	37x39x30	23 kg
219009	Counter Top 330	750W	3x140mm	330mm	1000	37x39x34	24 kg
219008	Counter Top 290 VS	750W	3x100mm	290mm	400-1500	37x39x30	26 kg
219010	Counter Top 330 VS	750W	3x140mm	330mm	400-1500	37x39x34	27 kg

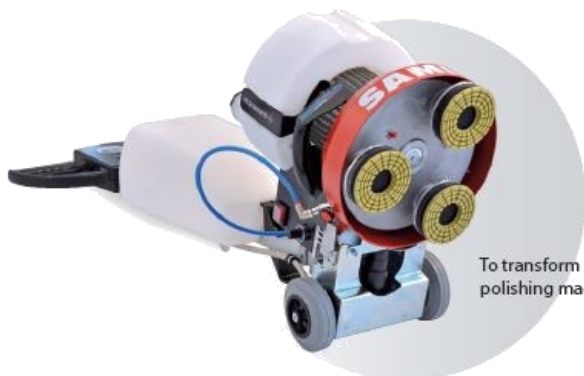

To transform it in a polishing machine



Long Handle optional

VÆRKTØJ TIL LEGEND COUNTER TOP

EASY KIT COUNTER TOP

Komplet Kit betående af Legend Counter Top, Vandtank 2L, Pad holder, komplet sæt Jaguar Flex fra G30 til G3500 og Trolley

Model

219507	Kit Counter Top 290
219509	Kit Counter Top 330
219508	Kit Counter Top 290 VS
219510	Kit Counter Top 330 VS



Jaguar Flex Ø100mm

401640	Jaguar flex grit 30 - Grøn	Ø100
401641	Jaguar flex grit 60 - M. Grøn	Ø100
401642	Jaguar flex grit 120 - Sort	Ø100
401643	Jaguar flex grit 220 - Rød	Ø100
401644	Jaguar flex grit 400 - Gul	Ø100
401645	Jaguar flex grit 800 - Hvid	Ø100
401646	Jaguar flex grit 1500 - Blå	Ø100
401647	Jaguar flex grit 3500 - Grå	Ø100



Jaguar Flex Ø140mm

401650	Jaguar flex grit 30 - Grøn	Ø140
401651	Jaguar flex grit 60 - M. Grøn	Ø140
401652	Jaguar flex grit 120 - Sort	Ø140
401653	Jaguar flex grit 220 - Rød	Ø140
401654	Jaguar flex grit 400 - Gul	Ø140
401655	Jaguar flex grit 800 - Hvid	Ø140
401656	Jaguar flex grit 1500 - Blå	Ø140
401657	Jaguar flex grit 3500 - Grå	Ø140

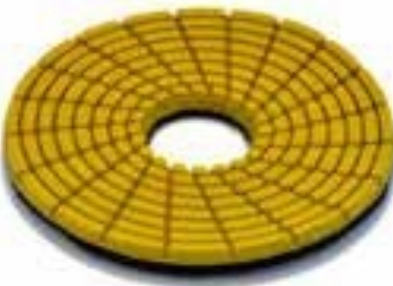

Velcro pad holder

401660	Velcro pad holder CounterTop 330	Ø140
401661	Velcro pad holder CounterTop 290	Ø100



Counter Top Handles m/ vand tank

219512	Short Handle m/ tank 8L	CT 290/330
401661	Long Handle m/ tank 12L	CT 290/330

[RAPTOR PADS] 

- Fjerner klæbende belægninger fra betongulve.
- Epoxy, latex, lim, tjære.
- Fjernelse af asbest
- Skraber og sliber i én bevægelse

Passer på KFG550 og KFG750

Hul	Varenr.	Antal Seg.	Segmentmål (l x h x b)	Kode
M6	220302	2	17 x 5,0 x 5,5	PRAM604
M6	220312	2	17 x 7,5 x 6,0	PRAM607
M6	220303	3	17 x 5,0 x 5,5	PRAM605
M6	220313	3	17 x 7,5 x 6,0	PRAM608
M6	220304	4	17 x 5,0 x 5,5	PRAM606
M6	220314	4	17 x 7,5 x 6,0	PRAM609

[QFD PADS] 

- Grov slibning af beton
- Fjernelse af ekstra tykkelse

Passer på KFG550 og KFG750

Hul	Varenr.	Antal Seg.	Segment-højde	Kode
M6	220342	2	20	QFD87M602
M6	220343	3	20	QFD87M603



Passer på de fleste maskiner med pads for undersækning.

Hul	Varenr.	Antal Seg.	Segment-højde	Kode
Undersænket	224142	2	20	QFD87FR02
Undersænket	224143	3	20	QFD87FR03

[RAPTOR PLATE]    

- Fjerner klæbende belægninger fra betongulve.
- Epoxy, latex, lim, tjære.
- Fjernelse af asbest
- Skraber og sliber i én bevægelse
- Passer bl.a. på: Errut, Bewag, SMG, HTC, Blastrac, King, Diamatic
- Ø250mm plade med 19mm centerhul

Varenr.	Antal pads	Antal Seg.	Segmentmål (l x h x b)	Kode
224181	8	3	17 x 5,0 x 5,5	PRC250.01
224191	8	3	17 x 7,5 x 6,0	PRC250.04
224182	4 + 4	3 / 4	17 x 5,0 x 5,5	PRC250.02
224192	4 + 4	3 / 4	17 x 7,5 x 6,0	PRC250.05
224183	8	4	17 x 5,0 x 5,5	PRC250.03
224193	8	4	17 x 7,5 x 6,0	PRC250.06

Priserne er for en komplet plade med 8 pads.

[RAPTOR PADS]    

- Fjerner klæbende belægninger fra betongulve.
- Epoxy, latex, lim, tjære.
- Fjernelse af asbest
- Skraber og sliber i én bevægelse

Hul	Varenr.	Antal Seg.	Segmentmål (l x h x b)	Kode
Undersænket	224102	2	17 x 5,0 x 5,5	PRAFR04
Undersænket	224112	2	17 x 7,5 x 6,0	PRAFR07
Undersænket	224103	3	17 x 5,0 x 5,5	PRAFR05
Undersænket	224113	3	17 x 7,5 x 6,0	PRAFR08
Undersænket	224104	4	17 x 5,0 x 5,5	PRAFR06
Undersænket	224114	4	17 x 7,5 x 6,0	PRAFR09

Priserne er stykpriser.

[PAC PADS] 

- Grov til fin slibning af betongulve
- **SURF2:** Fjernelse af ekstra tykkelse, fjernelse af belægningsrester, planering af overflader, forberedelse af grove gulve til polering, forberedelse af ny coating.
- **SURF3:** Finslibning, fjerner næsten alle ridser.
- **SURF4:** Forberedelse til polering, giver et "satin-look" uden ridser.
- **SURF5:** Forberedelse til polering, giver et "gloss-agtigt look", sidste trin inden polering med resin-skiverne.

Passer på KFG550 og KFG750



Hul	Varenr.	Type	Antal Seg.	Segmentmål (l x h x b)	Kode
M6	226001	SURF1	1	50 x 10,5x12,5	PIC18M601
M6	220031	SURF2	1	48 x 10 x 12	PAC25M604
M6	220032	SURF2	2	48 x 10 x 12	PAC25M605
M6	220041	SURF3	1	48 x 10 x 12	PAC60M607
M6	220042	SURF3	2	48 x 10 x 12	PAC60M608
M6	220051	SURF4	1	40 x 10 x 10	PC150M601
M6	220052	SURF4	2	40 x 10 x 10	PC150M602
M6	220061	SURF5	1	40 x 10 x 10	PC300M601
M6	220062	SURF5	2	40 x 10 x 10	PAC150M604

Passer på de fleste maskiner med pads for undersækning.

Hul	Varenr.	Type	Antal Seg.	Segmentmål (l x h x b)	Kode
Undersænket	224001	SURF2	1	48 x 10 x 12	PAC25FR04
Undersænket	224011	SURF2	2	48 x 10 x 12	PAC25FR05
Undersænket	224002	SURF3	1	48 x 10 x 12	PAC60FR07
Undersænket	224012	SURF3	2	48 x 10 x 12	PAC60FR08
Undersænket	224003	SURF4	1	40 x 10 x 10	PC150FR01
Undersænket	224013	SURF4	2	40 x 10 x 10	PC150FR02
Undersænket	224004	SURF5	1	40 x 10 x 10	PC300FR01
Undersænket	224014	SURF5	2	40 x 10 x 10	PC300FR02

Priserne er stykpriser. Der skal 9 pads til et sæt. (3 plader med 3 pads)

[P16 PADS] 

- Overfladebehandling, fin slibning, planslibning af fliser
- Højt output, lang levetid.
- Passer bl.a. på: Errut, Bewag, SMG, HTC, Blastrac, King, Diamatic.
- Vælg mellem M6 eller undersænkede huller.

Hul	Varenr.	Antal Seg.	Segmentmål (l x h x b)	Kode
Undersænket	225001	1	48 x 8 x 12	P16FR01
M6	225011	1	48 x 8 x 12	P16M601
Undersænket	225002	2	48 x 8 x 12	P16FR02
M6	225012	2	48 x 8 x 12	P16M602

Priserne er stykpriser.

[P20 PADS] 

- Overfladebehandling, fin slibning, planslibning af fliser
- Højt output, lang levetid.
- Passer bl.a. på: Errut, Bewag, SMG, HTC, Blastrac, King, Diamatic.
- Vælg mellem M6 eller undersænkede huller.

Hul	Varenr.	Antal Seg.	Segmentmål (l x h x b)	Kode
Undersænket	225101	1	33 x 7 x 7,5	P20FR01
M6	225111	1	33 x 7 x 7,5	P20M601
Undersænket	225102	2	33 x 7 x 7,5	P20FR02
M6	225112	2	33 x 7 x 7,5	P20M602
Undersænket	225103	3	33 x 7 x 7,5	P20FR03
M6	225113	3	33 x 7 x 7,5	P20M603

Priserne er stykpriser.

[NITTO 21]

- UV-beständig plastiktape
- 15mm x 10mtr.



Farve	Varenr.	Antal pakke/karton
Sort	521001	10 / 200 stk.
Iso-grå	521013	10 / 200 stk.
Rød	521004	10 / 200 stk.
L.Blå	521012	10 / 200 stk.

[NITTO 21]

- UV-beständig plastiktape
- 50mm x 20mtr.

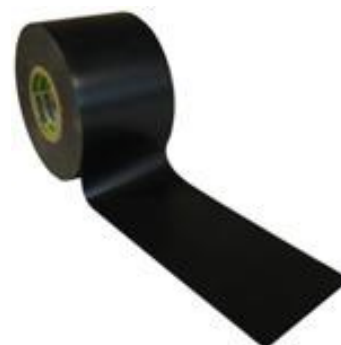

Farve	Varenr.	Antal karton
Sort	525001	48 stk.
Iso-grå	525013	48 stk.

[NITTO 21]

- UV-beständig plastiktape
- 100mm x 10mtr.



Farve	Varenr.	Antal karton
Sort	526001	40 stk.

[NITTO 228SK]

- UV-beständig plastiktape
- Flexibelt, også ved kuldegrader



Farve	Varenr.	Bredde (mm)	Længde (meter)	Antal karton
Sort	538201	19	20	120 stk.
Sort	538301	25	20	96 stk.
Sort	538401	38	20	60 stk.
Sort	538501	50	20	48 stk.



[NITTO 12FB]

- Vulkaniseringstape

Farve	Varenr.	Bredde (mm)	Længde (meter)	Antal karton
Sort	512038	38	1,5	10 stk.

**[NITTO 15]**

- Selvvulkaniserende tape

Farve	Varenr.	Bredde (mm)	Længde (meter)	Antal pakning
Sort	515195	19	5	10 stk.
Sort	515255	25	10	10 stk.
Sort	515385	38	10	5 stk.

**[NITTO 57Go]**

- En meget fleksibel tape af butylgummi for tætning, isolering og korrosionsbeskyttelse af uregelmæssige emner.
- Nedgravning af kabler, multianvendelse

Farve	Varenr.	Bredde (mm)	Længde (meter)	Antal karton
Sort	571502	150	2	1 stk.
Sort	571510	150	10	1 stk.

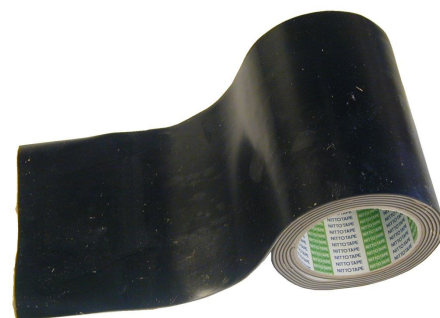
**[NITTO 51]**

- Ekstra kraftig tape, harpiksklæber
- Meget velegnet til beskyttelse ved sandblæsning

Farve	Varenr.	Bredde (mm)	Længde (meter)	Antal pakning
Sort	551301	25	10	160 stk.
Sort	551381	38	10	100 stk.
Sort	551501	50	10	80 stk.
Sort	551541	50	30,5	20 stk.



[NITTO 7288]

- Maskingtape

Farve	Varenr.	Bredde (mm)	Længde (meter)	Antal karton
Gul	588015	15	50	65 stk.
Gul	588019	19	50	50 stk.
Gul	588025	25	50	40 stk.
Gul	588038	38	50	25 stk.
Gul	588050	50	50	20 stk.

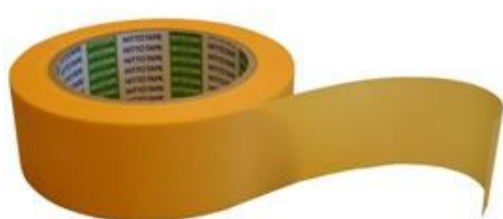

Nitto's no. 7288 er næste generations maskeringstape.

- Har en meget bedre holdbarhed end normale maskeringstaper.
- Efterlader ikke limrester efter brug, selv efter at have siddet i flere uger.
- Let at rive over med håndkraft.
- Høj klæbeevne under processen.
- Meget fin kant.
- Nemt at lave bløde kurver under påsættelse.
- Holder sin mekaniske styrke, så den knækker ikke ved aftagelse.
- Holder til høje temperaturer (150° i en time)
- Kan bruges både udendørs og indendørs.
- Kan også bruges under autolakering.

[CPA100]

- Flexibel, med varmesmeltet lim på indersiden.
- Indkapsling af bl.a. kabler, ledninger, splejsninger.
- Selvslukkende, temperatur område -55° C til 110° C
- Krympetemp.: Fra +120° C
- Gennemslagsspænding: 20KV/mm min
- Længder af 1,2mtr.

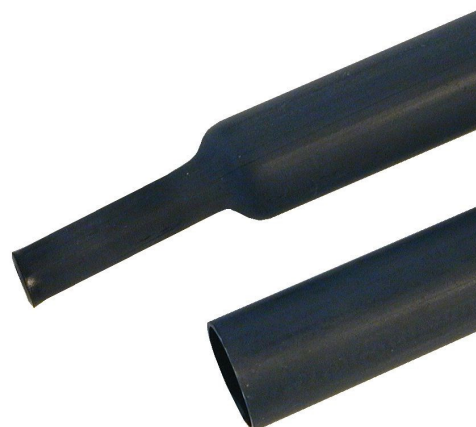

Ø	Krympefaktor	Varenr.
3,0	3:1	810030
4,0	4:1	810040
4,8	3:1	810048
6,0	3:1	810060
9,0	3:1	810090
12,0	3:1	810120
19,0	3:1	810190
24,0	3:1	810240
32,0	4:1	810320
40,0	3:1	810400
52,0	4:1	810520

Diaflex lagerfører også:

- Transperant krympeflex m/klæb
- Krympeflex i farver
- Krympeflex fra Ø1,2mm til Ø120mm
- Reparationsmuffer (lynlåsmuffer)
- Installatørsæt m.m.
- Krympetape 50mm - 300mm

[CFM-SEALANT]

- Mellemvægget, mastik-klæber
- Indkapsling af bl.a. kabler, ledninger, splejsninger.
- Selvslukkende, temperatur område -55° C til 110° C
- Kryp-temp.: Fra +120° C
- Gennemslagsspænding: 15kV/mm min
- Længder af 1,2mtr.
- Salgsenhed: 12 stk., gerne assorteret



Ø	Krympefaktor	Varenr.
12	3:1	870400
20	3:1	870750
30	3:1	871100
34	3:1	871300
40	3:1	871500
45	3:1	871700
54	3:1	872050
70	3:1	872750
93	3:1	873500
120	3:1	874000

[NEO-WRAP 1250]

- Krympetape, mastikklæber
- Sort, 10 mtr. rulle, krympfaktor 2:1



Bredde	Varenr.	Salgsenhed
50	1011050	6
100	1011100	4
150	1011150	2
200	1011200	2
300	1011300	1

[DFFR MINIBOX]

- Flexibel, uden klæber.
- Indkapsling af bl.a. kabler, ledninger, splejsninger.
- Selvslukkende.
- Krympetemp.: Fra +100° C
- Gennemslagsspænding: 15KV/mm min
- Krympefaktor 2:1



Ø (mm)	Længde (m)	Varenr.
1,6	10	700012
2,4	10	700024
3,2	10	700032
4,8	9	700048
6,4	8	700064
9,5	6	700095
12,7	6	700127
19,1	5	700191
25,4	3	700254

[DFUM MINIBOX]

- Flexibel, sort, dobbeltvægget, hotmelt klæber.
- Indkapsling af bl.a. kabler, ledninger, splejsninger.
- Selvslukkende, temperatur område -55° C til 110° C
- Krympetemp.: Fra +120° C
- Gennemslagsspænding: 20KV/mm min
- Krympefaktor 3:1



Ø (mm)	Længde (m)	Varenr.
3,0	5,0	800301
4,5	4,0	800451
6,0	3,5	800601
9,0	3,0	800901
12,0	2,5	801201

[DURASEAL]

- Vandtæt kabelsko og rørsamler
- Leveres i pakninger af 100 stk.



Farve	Størrelse (mm ²)	Varenr.
Rød	0,5 - 1,5	890110
Blå	1,5 - 2,5	890111
Gul	2,5 - 6,0	890112

[DUOFLEX]

- Vandtætte tinmuffer
- Leveres i pakninger af 100 stk.



Farve	Størrelse (mm ²)	Varenr.
Klar	0,1 - 0,5	890901
Rød	0,5 - 1,0	890902
Blå	1,5 - 2,5	890903
Gul	2,5 - 4,0	890904
Grå	4,0 - 6,0	890905

KONTAKT OS DIREKTE



Mogens Eskildsen

40 68 00 74



Jesper Kaster

20 32 60 32



Jan Christiansen

40 55 60 33



Lasse Olsen

22 22 41 71



Jørn Nørgaard

52 23 91 91



Mathias Harild

22 22 12 02



Filial: Håndværkervej 16, Roskilde
56 66 34 00

Lene Haus Vej 17B - 7430 Ikast
Vest 75 77 34 00 - Øst 56 66 34 00
www.diaflex.dk - diaflex@diaflex.dk

NYHED

DPH3500 Hybrid Boremotor fra Cardi.biz Italien

Diaflex A/S er officiel importør af Cardi Motor siden 2014. Cardi Motor har i år verdenspremiere på Hybrid Boremotor (3420W), der med Diamond Pulse Tech kan bore i beton med/ eller uden brug af vand. DPH3500 leveres med CDP 520 RIG indbygget med vibrationsdæmpende håndtag. Ring for en demo. DPH3500 er fremtiden.



DBH3000 Verdensnyhed fra Cardi.biz Italien

DBH3000 er det sidste skud på stammen af innovative løsninger fra Cardi Motor. DBH3000 er en kolossal kraftig 3000W, håndholdt eller monteret på Rig.

DPH3000 med Diamond Pulse Tech er løsningen – også når der skal bores uden vand i beton. Byggeriet i morgen vil efterspørge løsning for tørboring i beton. DBH3000 og DPH3500 fra Diaflex er svaret. Ring i dag.



SERVICECENTER FOR CARDI OG WEKA

VI AFHENTER OG LEVERER

Diaflex er importør og aut. servicecenter af Cardi Maskiner. Lasse Olsen er også et godt valg for jer til at reparere Weka, og de fleste andre maskiner, der bruges af bore- og skærefolket.

Ring trygt til Lasse 22 22 41 71
- I kender vores service



Diaflex A/S

Lene Haus Vej 17B, 7430 Ikast
75 77 34 00
www.diaflex.dk

Diaflex A/S Filial

Håndværkervej 16, 4000 Roskilde
56 66 34 00
www.diaflex.dk